

RADIO'S LIVEST MAGAZINE



January  
25 Cents

*Peter T. Jones*  
*Max T. Jones*  
*Walter*  
*Walter*

# Radio-Craft

*Walter*

HUGO GERNSBACK Editor

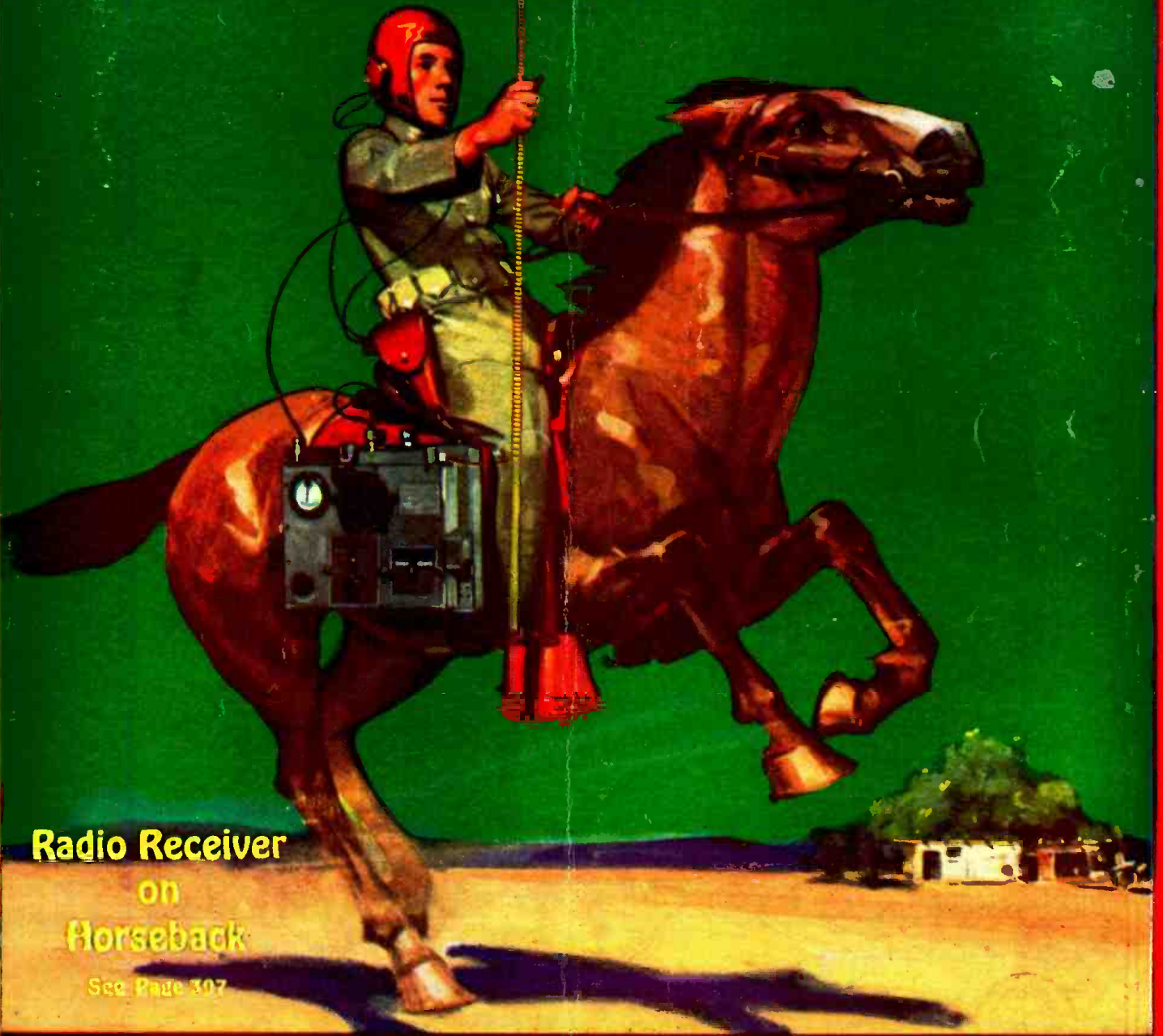

**Radio Receiver  
on  
Horseback**

See Page 307

**Servicing Direct-Coupled Audio Amplifiers    The Push-Push Power Amplifier  
The Radio-Controlled Piano    A Supernet Booster Stage    Portable Recorders**

# SPEED

## RADIO TUBES FOR ALL NEW RECEIVERS

*EVER ABREAST OF THE RADIO TIMES*

**SPEED** has achieved tremendous success  
with these **NEW** tubes. The reason  
is obvious—**QUALITY**



247

New power amplifier Pentode, for  
use in the output stage of AC  
receivers.

### Here They Are!

No. 235

New screen grid tube—designed to reduce  
cross modulation and similar distortion.

No. 551

New screen grid tube—designed for same  
purpose as type 235, although having  
slightly different characteristics.

No. 230

New general purpose tube, operating eco-  
nomically at 2 volts, giving unusual service  
though using very little power.

No. 231

New amplifier using 2 volts and extremely  
low current consumption in same group as  
types 230 and 232.

No. 232

New screen grid tube—for use as radio  
frequency amplifier, operating at 2 volts.

No. 233

New power amplifier in the Pentode group,  
operating on 2 volts with low current con-  
sumption.

No. 236

New screen grid tube used mainly as R.F.  
amplifier or detector in automobile sets.  
In same group as type 237 and 238. Also  
for use in D.C. sets.

No. 237

New general purpose tube—especially  
adapted to automobile use. Can be used  
either as a detector or amplifier. Also for  
use in D.C. sets.

No. 238

New power amplifier Pentode for use in  
automobile receivers designed for it. Gives  
unusual volume for small input signal  
strength.

No. S 84

Developed expressly for replacement of  
type C 484 in Sparton sets. Somewhat  
similar in characteristics to the type 227.

No. S 82 B

Developed expressly for replacement of the  
the C 183 in Sparton sets, possessing all  
peculiar characteristics necessary for this  
purpose.

No. S 83

Developed expressly for replacement of  
the C 183 in Sparton sets, possessing all  
the peculiar characteristics necessary for  
this purpose.

**SPEED** Quality is Making History Today. Write for Complete Details.

Still another addition to a big family. **SPEED** FOTO-LECTRIC TUBES.  
Standard gas-filled type, red sensitive, caesium on caesium-oxide silver-oxide.  
Six months guarantee against defects. Write for FOTO-LECTRIC folder.



**SPEED**  
CABLE RADIO TUBE CORPORATION

230-240 NORTH 9th STREET, BROOKLYN, NEW YORK

RCA  
LICENSED



# Train *with* R.T.A. *for* Radio Service Work

Important and far-reaching developments in Radio create sudden demand for specially equipped and specially trained Radio Service Men.



*This excellent  
set analyzer  
and trouble  
shooter included  
with our course  
of training*

**M**ANY skilled Radio Service Men are needed now to service all-electric sets. By becoming a certified R. T. A. Service Man, you can make big money, full time or spare time, and fit yourself for the big-pay opportunities that Radio offers.

We will quickly give you the training you need to qualify as a Radio Service Man . . . certify you . . . furnish you with a marvelous Radio Set Analyzer. This wonder instrument, together with our training, will enable you to compete successfully with experts who have been in the radio business for years. With its help you can quickly diagnose any ailing Radio set. The training we give you will enable you to make necessary analysis and repairs.

Serving as a "radio doctor" with this Radio Set Analyzer is but one of the many easy ways by which we help you make money out of Radio. Wiring rooms for Radio, installing and servicing sets for dealers, building and installing automobile Radio sets, constructing and installing short wave receivers . . . those are a few of the other ways in which our members are cashing in on Radio.

As a member of the Radio Training Association, you receive personal instruction from skilled Radio Engineers. Upon completion of the training, they will advise you personally on any problems which arise in your work. The Association will help you make money in your spare time, increase your pay, or start you in business. The easiest, quickest, best-paying way for you to get into Radio is by joining the Radio Training Association.

This amazing Radio Set Analyzer plus the instructions given you by the Association will transform you into an expert quickly. With it, you can locate troubles in all types of sets, test circuits, measure resistance and condenser capacities, detect defective tubes. Knowing how to make repairs is easy; knowing what the trouble is requires expert knowledge and a Radio Set Analyzer. With this Radio Set Analyzer, you will be able to give expert service and make big money. Possessing this set analyzer and knowing how to use it will be but one of the benefits that will be yours as a member of the R. T. A.

## Write for No-Cost Membership Plan

We have worked out a plan whereby a membership enrollment need not cost you a cent. Our thorough training and the valuable Radio set analyzer can be yours. Write at once and find out how easily both of these can be earned.

Now is the time to prepare to be a Radio Service Man. Greater opportunities are opening up right along. For the sake of extra money in your spare time, bigger pay, a business of your own, a position with a future, get in touch with the Radio Training Association of America now.

Send for this No-Cost Membership plan and Free Radio Handbook that will open your eyes as to what Radio has in store for the ambitious man. Don't wait. Do it now.

**RADIO TRAINING ASSOCIATION OF AMERICA**  
Dept. RCA-1      4513 Ravenswood Ave.      Chicago, Ill.

Fill Out and Mail Today!

**RADIO TRAINING ASSOCIATION OF AMERICA**  
Dept. RCA-1, 4513 Ravenswood Ave., Chicago, Ill.  
Gentlemen: Send me details of your No-Cost Membership Enrollment Plan and information on how to learn to make real money in radio quick.

Name .....

Address .....

City..... State.....

H. GERNSBACK, President  
 S. GERNSBACK, Treasurer  
 J. M. HERZBERG, Vice-President  
 I. S. MANHEIMER, Secretary



R. D. WASHBURN  
 Technical Editor

LOUIS MARTIN  
 Associate Editor

VOLUME III  
 NUMBER 7

## Contents of This Issue

JANUARY  
 1932

	PAGE		PAGE
<b>EDITORIAL:</b>			
Fourteen Million Radios in U. S.....By Hugo Gernsback	395	The Service Man's Forum.....	411
<b>NEW DEVELOPMENTS IN RADIO:</b>			
The Autoverter.....By R. D. Washburne	396	Contest Notice .....	411
Radio Reception on Horseback.....By Louis Martin	397	<b>RADIO SERVICE DATA SHEETS:</b>	
New Radio Equipment .....	398	General Motors 7-Tube Superheterodyne Classes S1A	
The AAA-1 Diagonometer.....By H. G. Cisin	399	and S1B: Little General 250, Standish 216, Tudor	
The Telepiano .....	402	217 and Continental 219.....	412
<b>SERVICE MEN'S DEPARTMENT:</b>			
Replacing the Type '80 Rectifier with a Mercury-Vapor		Delco 32-Volt Radio Receiver Chassis.....	413
Tube .....	401	Service-Selling "All-Wave" Supers	418
By Paul Schwerin		By McMurdo Silver	
By Sidney Fishberg	403	<b>SOUND RECORDING DEPARTMENT:</b>	
Time and the Radio Service Man.....	405	How to Build a Portable Recorder.....By Geo. J. Saliba	414
By Clifford E. Denton	406	<b>TECHNICAL RADIO TOPICS:</b>	
By Harry Georges	408	Selectivity.....By C. H. W. Nason	404
Operating Notes		A New System of Static Reduction	
By Glenn E. Denner	409	By Henri F. Dalpayrat	405
By William Murrills	409	Push-Push Power Amplifiers.....By C. H. W. Nason	415
By John D. Hayden, Jr.	409	A Superhet Booster Stage.....By Henry C. McCarty	416
By Nathan Silverman	410	A Modern All-Wave "Super".....By W. H. Hollister	417
<b>Favorite Testing Equipment of Service Men</b>			
A Set Analyzer for the Beginner		Radio Kinks.....By RADIO-CRAFT Readers	419
		The Radio Craftsman's Page.....By Himself	420
		Contest Notice .....	420
		RADIO-CRAFT'S Information Bureau.....	422
		Thousands of Broadcast Stations.....	425
		Book Review .....	413

## In Forthcoming Issues

**RECEIVERS WITH PUSH-PUSH AMPLIFICATION.** Technical descriptions of two sets designed to include an audio amplifier of the "push-push" type described in this issue of RADIO-CRAFT.

**CONSTRUCTION AND USE OF THE GOOSE-NECK V.T. VOLTMETER.** The "how" and "why" of a unit meeting average laboratory specifications. Fine for use in servicing direct-coupled amplifiers, etc.

**COLD CATHODE TUBES.** An interesting description of a filament-less vacuum tube, with numerous advantages over existing types, which it is expected will take the place of the latter in new receiver designs.

**RADIO FREQUENCY PENTODES.** The newest developments in pentodes, which makes it possible to realize in R.F. circuits many of the advantages heretofore available only in A.F. connections.

RADIO-CRAFT is published monthly, on the fifth of the month preceding that of date; its subscription price is \$2.50 per year. (In Canada and foreign countries, \$3.00 a year to cover additional postage.) Entered at the postoffice at Mt. Morris, Ill., as second-class matter under the act of March 3, 1879. Trademarks and copyrights by permission of Gernsback Publications, Inc., 98 Park Place, N. Y. C.

Text and illustrations of this magazine are copyright and must not be reproduced without permission of the copyright owners. We are also agents for WONDER STORIES and WONDER STORIES QUARTERLY. Subscriptions to these magazines may be taken in combination with RADIO-CRAFT at reduced Club rates. Write for information.

Copyright 1931. GERNSBACK PUBLICATIONS, INC.

Published by  
**TECHNI-CRAFT PUBLISHING CORPORATION**

Publication Office: 404 No. Wesley Ave., Mount Morris, Illinois

Editorial and Advertising Offices  
 96-98 Park Place, New York City

Chicago Advertising Office  
 737 North Michigan Avenue, Chicago, Ill.

Western Advertising Office  
 220 No. Catalina St., Los Angeles, Calif.

L. F. McCLURE, Chicago Advertising Representative

LOYD B. CHAPPELL, Western Advertising Representative

London Agent: Hachette & Cie.,  
 3 La Belle Sauvage Ludgate Hill, E.C. 4

Paris Agent: Hachette & Cie.,  
 111 Rue Reaumur

Australian Agent: McGill's Agency,  
 179 Elizabeth St., Melbourne



# Big Pay Jobs for Trained RADIO Men

# 5000

## Service Men Needed



ACTUAL PHOTOGRAPH OF STUDENTS WORKING IN SERVICE DEPT. OF COYNE RADIO SHOPS

# LEARN RADIO~TELEVISION TALKING PICTURES AT COYNE

## TEN WEEKS of SHOP TRAINING on RADIO EQUIPMENT

Dissatisfied with your job? Not making enough money? Then let me show you how to prepare for a real job and how to make real money, in RADIO—one of the fastest growing, biggest money-making trades on earth.

### JOBS LEADING TO BIG PAY

Scores of jobs are open—jobs as Designer, Inspector and Tester—as Radio Salesman and in Service and Installation work—as Operator or Manager of a Broadcasting Station—as Wireless Operator on a Ship or Airplane—with Talking Picture Theatres and Manufacturers of Sound Equipment—with Television Laboratories and Studios—fascinating jobs, offering unlimited opportunities to the Trained Man.

H. C. Lewis, Pres. **Radio Division** **Founded 1899**  
**COYNE ELECTRICAL SCHOOL**  
500 S. Paulina Street Dept. 12-8H Chicago, Illinois

### PRACTICAL Shop Training

Come to Chicago and prepare for these jobs the QUICK and PRACTICAL way—BY ACTUAL SHOP WORK on ACTUAL RADIO EQUIPMENT. Some students finish the entire course in 8 weeks. The average time is only 10 weeks. But you can stay as long as you please, at no extra cost to you. No previous experience necessary.

### Broadcasting — Television Sound Equipment

In addition to the most modern Radio equipment, we have installed in our Shops a complete model Broadcasting Station, with sound proof Studio and modern Transmitter with 1,000 watt tubes—the Jenkins Television Transmitter with dozens of home-type Television receiving sets—and a complete Talking Picture installation for both "sound on film" and "sound on disk." We have spared no expense in our effort to make your training as COMPLETE and PRACTICAL as possible. Mail the coupon for full particulars!

### Free Employment Service TO STUDENTS

After you have finished the course, we will do all we can to help you find the job you want. We employ three men on a full time basis whose sole job is to help our students in finding positions. And should you be a little short of funds, we'll gladly help you in finding part-time work while at school. Some of our students pay a large part of their living expenses in this way. Get all the facts!

### COYNE IS 32 YEARS OLD

Coyne has been located right here in Chicago since 1899. Coyne Training is tested—proven by hundreds of successful graduates. You can get all the facts absolutely free. JUST MAIL THE COUPON FOR A FREE COPY OF OUR BIG RADIO AND TELEVISION BOOK.

H. C. LEWIS, President  
Radio Division, Coyne Electrical School  
500 S. Paulina St., Dept. 12-8H Chicago, Ill.

Send me your Big Free Radio, Television and Talking Picture Book. This does not obligate me in any way.

Name.....

Address.....

City.....State....

# FREE Supplements are mailed every 60 days to owners of the 1932 Official Radio Service Manual

## FREE Questions and Answers Service

### Schematic Diagrams of All Latest Midget Receivers

*Expert servicing or installation of radio receivers requires that the dealer, service man or radiotrician be thoroughly experienced in handling sets of any manufacture. Needless to mention how important are modern methods of servicing, and how easy it is to complete any service job when the OFFICIAL RADIO SERVICE MANUAL is on hand. The NEW 1932 MANUAL contains a Full Radio Service Guide and a most Complete Directory of all 1931-1932 Radio Receivers as well as models of older design. Everyone employed in the Radio Industry should have a copy available for his own use.*

**\$5.00**

The Copy

HUGO GERNSBACK,  
Editor

C. E. Denton  
Managing Editor

Clyde Fitch,  
Managing Editor

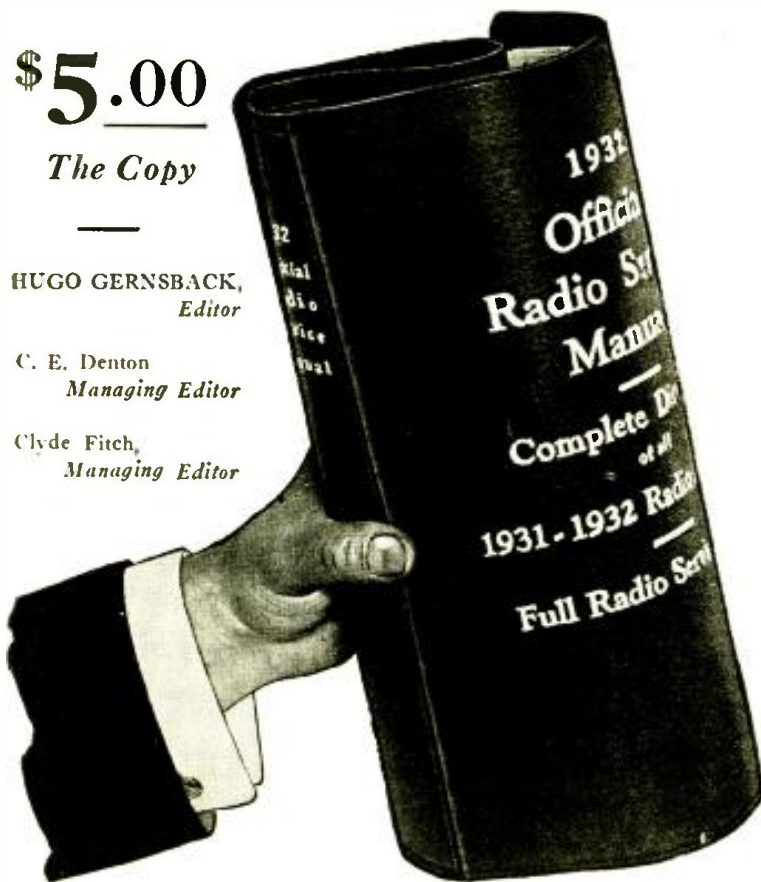

### Partial Contents of the Manual

A step-by-step analysis in servicing a receiver which embodies in its design every possible combination of modern radio practice; it is fully illustrated and thoroughly explained. It is the greatest contribution to the radio service field.

Chart showing the operation of all types of vacuum tubes, whether new, old or obsolete. An exclusive resumé of the uses of the Pentode and Variable Mu Tubes and their characteristics.

Complete discussion of the superheterodyne and its inherent peculiarities. Also a special chapter on tools used on superheterodyne circuits.

Schematic diagrams and circuits complete with color codings.

Important chapters on commercial aircraft radio equipment; new data on commercial short wave receivers and converters.

Servicing and installation of public address systems and talking machine equipment.

Standardized color codings for resistors.

Operation of old and new testing equipment; tube voltmeters, output meters, oscillators and aligning tools.

A full section on Midget radios—their design, circuits and types. How to service them most economically.

Hundreds of schematic diagrams of older radio receivers which have never been published.

Blank pages for recording notes, diagrams and sketches; these pages are transferable to any part of the book.

OVER 1,000 PAGES

Over 2,000 Diagrams,  
Charts and Illustrations

Flexible Loose Leaf Binder  
9 x 12 Inches

Complete Directory  
of All 1931-1932  
Radio Receivers

Full Radio Service Guide  
For Radio Service Men,  
Dealers, Jobbers, Manu-  
facturers and Set  
Builders

Clip Coupon NOW!

GERNSBACK PUBLICATIONS, Inc., RC-132  
96-98 Park Place, New York, N. Y.

I enclose herewith remittance of \$5.00, check or money order preferred, for which you are to send me the NEW 1932 OFFICIAL RADIO SERVICE MANUAL. I understand that all the New material will be included in the Manual and Supplements will be mailed FREE every 60 days.

Name .....

Address .....

City ..... State.....



# 'Round the World Reception Every day, in all seasons

21 weeks, constant reception record from VK3ME proves SCOTT ALL-WAVE capable of tuning in clear 'round the earth regularly—every day, summer and winter.

FOR 21 weeks, a Scott All-Wave Receiver, located in Chicago has brought in, and recorded on disc, every broadcast from VK3ME, Melbourne, Australia. Each broadcast was received with perfect clarity and full volume—as the disc records decisively prove. Think of it! VK3ME, half way 'round the earth! Not just once in a while. Not just a freak happenstance. As this book goes to press, VK3ME is still being received with perfect regularity, and recorded. With a Scott All-Wave, you could get VK3ME and dozens of other foreign phone stations whenever you choose.

When the distance between Melbourne and Chicago is used as a radius, a circle drawn from Chicago as the center, includes practically the entire world. This establishes the range of the Scott All-Wave Receiver, and steady reception from all points north, south, east and west, at the extremes of the circle, PROVE the world-wide range of this remarkable instrument.

The reason for the greater range of the Scott All-Wave is the far greater amplification obtained in its intermediate stages. A new type of transformer, in which the primary is shielded from its secondary, provides such an enormous increase in gain per stage that the sensitivity of the receiver is more than adequate for world-wide reception, with the tubes operated below the noise level. Short Wave reception that is ordinarily attended with terrific interference, comes in clearly on the Scott All-Wave—and with beautiful, full, round, natural tone. Reception from VK3ME, from G5SW, Chelmsford, England, from 12RO, Rome and other

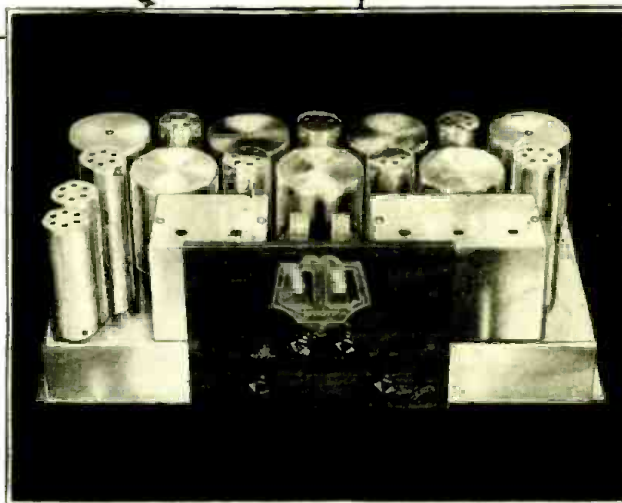
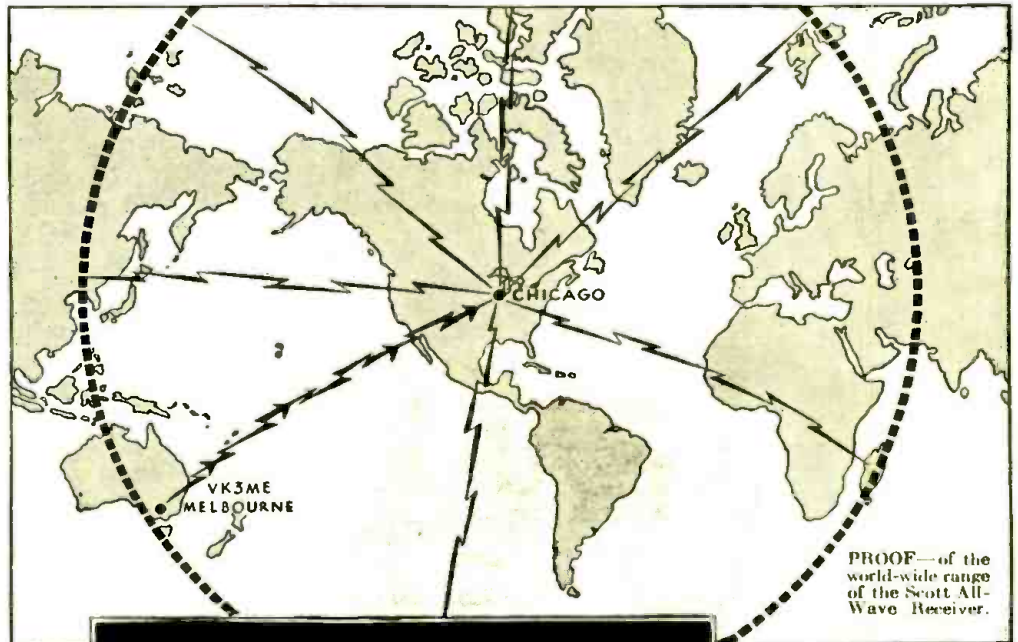

The Beautiful Chrome Plated Scott All-Wave Chassis

far off points, invariably has the quality and volume of a local station! Actually, in all truth, the Scott All-Wave gives 'round the world reception every day, in all seasons—between 15 and 550 meters.

### FIVE YEAR GUARANTEE

The Scott All-Wave is not a factory product. Rather, it is built in the laboratory, by laboratory experts and to laboratory standards. For that reason, we can make the most unusual guarantee ever made on a radio receiver. The Scott All-Wave is guaranteed for full five years against defective material or workmanship. Any part that fails within that time will be replaced FREE OF CHARGE.

### Mail Coupon Today

Full particulars of the Scott All-Wave will be of immense interest to you. Get them now. Read all about the receiver that challenges the whole realm of radio to any kind of competitive test. The coupon below will bring them. Clip it—fill it in—mail it today.

THE E. H. SCOTT RADIO LABORATORIES, Inc.  
(Formerly Scott Transformer Co.)

4450 Ravenswood Avenue - Dept. C-1 - Chicago, Ill.

## The SCOTT ALL-WAVE

### 15-550 METER SUPERHETERODYNE

### CLIP—MAIL NOW

THE E. H. SCOTT RADIO LABORATORIES, Inc.  
4450 Ravenswood Ave., Dept. C-1 Chicago, Ill.

Send me full details of the Scott All-Wave Receiver.

Name.....

Street.....

Town..... State.....



Broadcasting Stations offer fascinating jobs paying from \$1,200 to \$5,000 a year.



Police Departments are finding Radio a great aid in their work. Many good jobs have been made in this new field.



Spare time set servicing is paying N.R.I. men \$200 to a \$1,000 a year. Full time men are making as much as \$65, \$75, \$100 a week.



Talking Movies—an invention made possible only by radio offers many fine jobs to trained radio men paying \$75 to \$200 a week.



Television—the coming field of many great opportunities—is covered by my course.

# You're Wanted

## Take your pick of these fine Big Pay Radio Jobs

**Y**OU have seen how the men and young men who got into the automobile, motion picture and other industries when they were started had the first chance at the key jobs—are now the \$5,000, \$10,000 and \$15,000 a year men. Radio offers you the same chance that made men rich in those businesses. Its growth has already made men independent and will make many more wealthy in the future. Its amazing growth can put you ahead, too. Don't pass up this opportunity for a good job and future financial independence.

**Many Fine, \$50 to \$100 a Week Jobs Opening Every Year**

Radio needs more trained men badly. Why slave your life away for \$25 to \$40 a week in a no-future job when you can get ready in a short time for Radio where the good jobs pay \$50, \$60, \$75 and \$100 a week? And many of these jobs can quickly lead to \$150 to \$200 a week. Many fine jobs are opening every year for men with the right training—the kind of training I'll give you.

**I Am Doubling and Tripling Salaries**

Where you find big growth you always find many big opportunities. I am doubling and tripling the salaries of many men every year. After training with me only a short time they are able to make \$1,000 to \$3,000 a year more than they were getting before. Figure out for yourself what an increase like this would mean to you—the many things that mean so much in happiness and comfort that you could buy with an additional \$1,000 to \$3,000 a year.

**Many Make \$10 to \$25 a Week Extra Almost at Once**

The day you start I'll show you how to do 28 jobs common in most every neighborhood that you can do in your spare time. I'll show you how to repair and service all makes of sets and do many other jobs all through my course. I'll give you the plans and ideas that are making \$200 to \$1,000 for my students while they are taking my course. G. W. Page, 2210 Eighth Ave., So., Nashville, Tenn., writes: "I made \$935 in my spare time while taking your course."

**You Have Many Jobs to Choose From**

Broadcasting stations use engineers, operators, station managers. Radio manufacturers continually need testers, inspectors, foremen, engineers, service men, buyers and managers. Shipping companies, Police departments, commercial land stations, aircraft companies, offer good operators jobs from time to time. There are hundreds of opportunities for you to have a spare time or full time Radio business of your own. I'll show you how to start one with practically no capital. My book tells you of other opportunities. Be sure to get it at once.



**\$100 a Month**

"I spent fifteen years as traveling salesman and was making good money but could see the opportunities in Radio. Believe me I am not sorry, for I have made more money than ever before. I have made more than \$400 each month and it really was your course that brought me to this. I can't say too much for your school." J. G. DAHLSTAD, Radio Station KYA, San Francisco, Cal.



**\$800 in Spare Time**

"Money could not pay for what I got out of your course. I did not know a single thing about Radio before I enrolled but I have made \$800 in my spare time although my work keeps me away from home from 6:00 A. M. to 7:00 P. M. Every word I ever read about your course I have found true." MILTON I. LEIBY, JR., Tipton, Pennsylvania.



**Seldom Under \$100 a Week**

"My earnings in Radio are many times greater than I ever expected them to be. In November I made \$577, December \$645, January \$465. My earnings seldom fall under \$100 a week. I'll say the N. R. I. course is thorough and complete. You give a man more for his money than anybody else. E. E. WINBORNE, 1267 W. 48th St., Norfolk, Va.



# for a **Big Pay** Radio Job



## I will train you AT HOME free book gives facts and proof

### I Will Train You at Home In Your Spare Time

Hold your job. There is no need for you to leave home. I will train you quickly and inexpensively during your spare time. You don't have to be a high school graduate. My course is written in a clear, interesting style that most anyone can grasp. I'll give you practical experience under my 50-50 method of training—one half from lesson books and one-half from practical experiments. When you graduate you won't have to take any kind of a job to get experience—you will be trained and experienced ready to take a responsible job in the radio field of your choice.

### Television and Talking Pictures Included

My course not only gives you a thorough training in Radio—all you need to know to get and hold a good job—but also your choice, without extra charge, of any one of my special advanced courses: 1. Television; 2. Aircraft Radio; 3. Broadcasting, Commercial and Ship Radio Stations; 4. Sound Pictures and Public Address Systems; 5. Advanced Radio Servicing and Merchandising. You won't be a "one job" man when you finish my course. You'll know how to handle a job in any one of Radio's 20 different branches of opportunity.

**J. E. SMITH, President**

**NATIONAL RADIO INSTITUTE**

**Dept. 2-AX**

**WASHINGTON, D. C.**

### Lifetime Employment Service to All Graduates

When you finish my course you won't be turned loose to shift for yourself. Then is when I will step in to help you find a job through my Employment Department. This Employment Service is free of extra charge both to you and the employer.

### Your Money Back If Not Satisfied

You do not risk a penny when you enroll with me. I will give you an agreement in writing, legal and binding upon the Institute, to refund every penny of your money if upon completing my course you are not satisfied with my Lessons and Instruction Service. The resources of the N. R. I., Pioneer and Largest Home Study Radio training organization stands back of this agreement.

### Find Out What Radio Offers You—Get My Book at Once

One copy of my valuable book, "Rich Rewards in Radio," is free to anyone interested in making more money. It tells you where the good jobs are, what they pay, how you can quickly and easily fit yourself to get one. The coupon below will bring you a copy. Send it at once. Your request does not obligate you in any way. Act NOW.

# I give You 8 Big Outfits of Radio parts for Extensive Practical Experiments

You can build over 100 circuits with these outfits. You build and experiment with the circuits used in Crosley, Atwater-Kent, Eveready, Majestic, Zenith and other popular sets. You learn how these sets work, how to make them work. This makes learning at home easy, fascinating, practical.

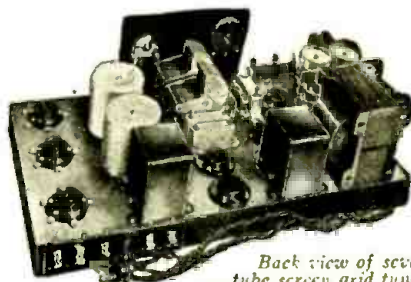

Back view of seven tube screen grid tuned Radio frequency receiver  
—only one of many circuits you can build.

## Special Offer

Service Manual on Trouble Shooting in Radio Sets  
Sent Free



Act now and receive in addition to my big free book "Rich Rewards in Radio," this Service Manual on D.C., A.C., and Battery operated sets. Only my students could have this book in the past. Now readers of this magazine who mail the coupon will receive it free. Overcoming hum, noises of all kinds, fading signals, broad tuning, howls and oscillations, poor distance reception, distorted or muffled signals, poor Audio and Radio Frequency amplification and other vital information is contained in it. Get a free copy by mailing the coupon below.



### Salary Three Times Larger

"Before I completed your course I went to work for a Radio dealer. Now I am Assistant Service Manager of the Sparks-Withington Company. My salary is three times what it was before taking your course. I could not have obtained this position without it. I owe my success to N. R. I. training." H. A. WILMORN, Sparks-Withington Co., Jackson, Mich.



## Clip and mail NOW for FREE INFORMATION

J. E. Smith, President,  
National Radio Institute, Dept. 2 A X,  
16th and U Sts., N. W., Washington, D. C.

I want to take advantage of your special free offer. Send me your two books "Rich Rewards in Radio" and "Trouble Shooting in D.C., A.C. and Battery Sets." I understand this request does not obligate me and that no salesman will call.

Name .....

Address .....

City..... State.....

**RECAPTURE**  
*the THRILL of*  
**EARLY RADIO**  
**RECEPTION**

*Hear the*  
*Short-Wave Stations*  
*of the World: direct*  
**With the NEW PILOT**

**SUPER-WASP**

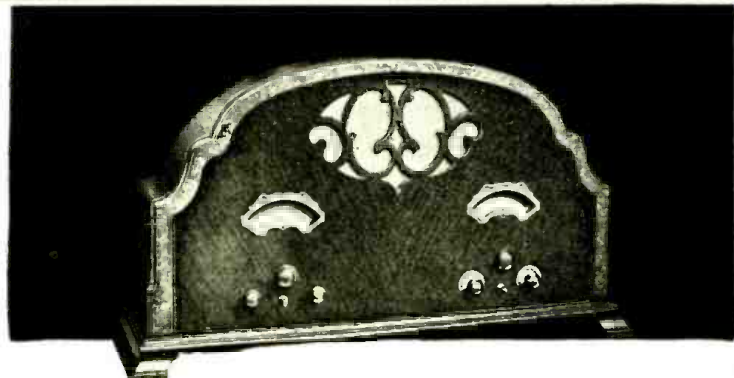

This 4-tube Short-Wave Converter transforms any modern radio receiver into a short-wave set instantly. Complete with newest type tubes, including rectifier.

**\$39.50**

Day or night, Pilot's marvelous SUPER-WASP brings in all kinds of new and startling things—airplane-to-ground conversations, transoceanic telephone calls, foreign broadcasting stations and, most exciting of all, police headquarters in a dozen cities talking to their radio-equipped "emergency cruisers." This 11-tube Super-heterodyne has separate controls for the broadcast band, with special high quality, high selectivity circuit. Including newest type tubes and built-in dynamic speaker. **\$99.50**

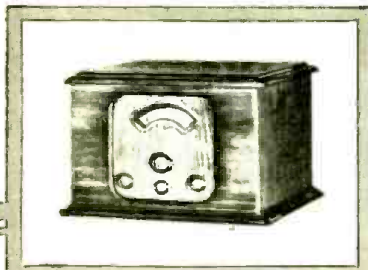

Pilot Radio & Tube Corporation  
 Lawrence, Mass.

Please send me complete information about:

- The new SUPER-WASP
- The 4-tube Converter
- I enclose 50c for one year's subscription to Radio Design beginning with the current issue.

Name..... City..... State.....



# The Largest Variety of Tubes in the World

PENTODES — SCREEN GRIDS — VARIABLE MUS — POWER AMPLIFIERS — DETECTORS — PHOTOELECTRIC CELLS — TELEVISION — RECTIFIER AND CHARGER BULBS

30 Day Replacement on Every Tube Sold!

All Tubes Guaranteed to be First Grade Quality

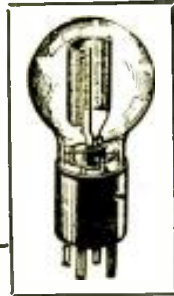

TYPE A  
Caesium Photo  
Cells, overall  
length 4 1/2".  
\$7.90

**M**ANY tubes for special purposes are listed here that cannot be gotten elsewhere. The prices are low when you consider the long service that these tubes will give you—There are no better tubes made than ARCO, regardless of price.

Such an amazing tube sale has never been conducted.

**COMPLETE STOCK ALWAYS READY FOR IMMEDIATE SHIPMENTS**

Order from this page and note the following terms: No order accepted for less than \$5.00. It is not necessary to send the full amount of cash with the order as long as your order is accompanied by 20% of the value. Shipment will go forward to you by express or parcel post C. O. D. All prices are F. O. B. Factory, Newark.

TYPE	ANY QUANTITY
UX-201A—Amplifier or detector.....	\$0.30
UX-226 —AC amplifier .....	.30
UY-227 —AC amplifier or detector.....	.30
UY-171A—Power output amp. for AC or DC operation, 1/4 amp. ....	.30
UX-171 —Same characteristics as 171A on tungsten filament, 1/2 amp. ....	.30
UX-240 —Designed for impedancer and resistance coupling.....	.40
UX-120 —Power amp. used in last stage of audio freq.....	.40
UX-199 —Detector and amp. tube, long prongs.....	.40
UV-199 —Same characteristics as UX-199 only short prongs.....	.40
UX-112 —Power amplifier tube, 1/2 amp.....	.40
UX-112A—Power amp. tube for low cur. consump., 1/4 amp.....	.40
UX-200A—Detector tube recommended for weak signals and good reception.....	.40
UY-224 —AC screen grid amplifier.....	.40
UX-245 —Power amplifier .....	.40
Quadrode 5-prong 201A for special circuit.....	.60
Special detector tube 200A—a super-sensitive detector.....	.60
Special radio frequency 201A—a super-sensitive 201A.....	.60
Special audio frequency 201A—a super-sensitive 201A.....	.60
Special 171 AC 1/2 amp. extra coated filament—good for electric sets.....	.60
T-14 (201A High Mn) high emission.....	.60
Switch tube, 201A or 112 or 171 double life.....	.60
Adapter tube 226, 227, 171A, to convert bat. sets to AC, each.....	1.10
UX-210 —For power amplifier, high voltage.....	1.10
UX-250 —Power amp. used in last stage of audio freq.....	1.10
UX-222 —Screen grid radio frequency amp.....	1.10
Telion Television Tube, 1" Cathode Square Type X.....	3.85
Telion Television Tube, 1 1/2" Cathode Square Type V.....	3.85
Photoelectric cell, "Potassium" Type O.....	3.85
Photoelectric cell, "Caesium" Type A.....	7.90
Photoelectric cell, "Caesium" Type R.....	5.90
WD-11—Detector Amp. ....	.60
WD-12—Detector Amp. ....	.60
UX-182 —Sparton Type .....	.85
UX-183 —Sparton Type .....	.85
UX-484 —Sparton Type .....	.85
UY-585 —Sparton Type .....	.85
UX-686 —Sparton Type .....	.85
UX-401 —Kellogg Type .....	1.50
UY-277A—AC amplifier or detector same as 227 but (quick heater).....	.60
UY-224A—AC screen grid amplifier same as 224 but (quick heater).....	.60
UX-233 —Power Amplifier Pentode, 2 volts.....	.85
UY-236 —Screen Grid Radio Freq. Amp.....	.85
UY-237 —Detector Amplifier .....	.85
UY-238 —Power Amplifier Pentode.....	.85
UX-230 —Dry cell amp. and detector, 2 volts.....	.60
UX-231 —Dry cell amp.—last audio stage, 2 volts.....	.60
UX-232 —Dry cell screen grid amp., 2 volts.....	.60
UY-247 —Power pentode .....	.85
UY-235 —Super control screen grid amp.....	.85
UY-551 —Variable Mu .....	.85
Ballast tube to prevent tubes in set from blowing out.....	1.00

**RECTIFIER AND CHARGER BULBS**

125 Mil. rectifying tube (B. H.) (Raytheon Type).....	\$1.40
6/10 amp. trickle charger bulb (Tungar Type).....	2.00
2 amp. old and new type charger bulbs (list \$4.00) (Tungar Type).....	2.00
5 and 6 amp. charger bulbs (list \$8.00) (Tungar Type).....	3.75
15 Amp. charger bulbs (Tungar Type).....	7.50
UX-280 —Used as a full-wave rectifier for high emission.....	.40
UX-281 —Half wave rectifier.....	1.10
Rectifying Tube especially designed for use with Freshman Master "B" Eliminators UV brass base, limited quantity.....	.30
UX-866 —Mercury Vapor Half Wave Rectifier .....	3.75



A.C. Adapter Tubes  
to convert battery  
sets into A.C. Elec-  
tric sets — furnished  
for 226, 227, 171A.  
\$.60



New Type Old Type  
2-Amp. Charger  
Bulbs. \$2.00



5 and 6 Amp. Charger  
Bulbs. \$3.75



Telion Television  
Tube \$3.85



5-Prong 201A  
\$.60

**DISCOUNTS:** 100 TUBES AND OVER 10%  
500 TUBES AND OVER 10% AND 10%

**ARCO TUBE COMPANY** 38-40 PARK PLACE, NEWARK, N. J

# Build Your CUSTOMERS THE Revolutionary STENODE



STENODE selectivity curve makes 10KC selectivity, so-called, look like broad tuning.

STENODE selectivity is compared, at left, to that of ordinary receivers. All background noise is contained in outer curve. Stenode's curve, shaded, contains but 1-10 the total noise.



STENOTUBE. Only one required in each Stenode. This heart of the Stenode circuit consists of a quartz crystal ground to 175KC frequency and mounted in tube form for easy handling. Standard UX socket base. Price \$15.

Made in England

None genuine without the inventor's signature.

*James Robinson*

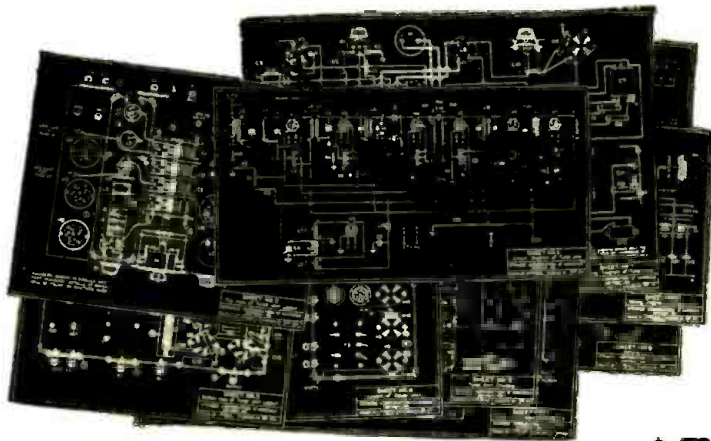

## The Receiver That Is **NOISE FREE** on **SHORT WAVES** or **BROADCAST**

A STENODE demonstration will create more new custom set prospects than any radio receiver ever did before. People listen in amazement when they hear stations free of background noises and absolute silence between stations. When you tune out heterodynes and whistles and stations **STAY IN** strong and crystal clear, owners of all other sets gasp in astonishment. The former chief of wireless research of the British Royal Air Force, Dr. James Robinson has given an entirely new principal to radio in STENODE.

By the STENODE principal the highest selectivity ever attained as well as unprecedented tonal range is now made possible. All engineers agree that it is impossible with ordinary superheterodynes.

STENODE amplifies signals most and static least. That's why YOU want to build an 11 tube STENODE to work with a **SHORT WAVE** adapter when it is not used to log and listen with enjoyment to more broadcasters than can be heard on any othertype of radio. STENODE selectivity is 5 to 1 greater than that of so called 10KC Supers. The noise does not get in along with the high audio frequencies, and the STENODE reproduces perfectly higher frequencies than ever heard on any other receiver giving

**500% BETTER SELECTIVITY**  
**1000% MORE FREEDOM FROM NOISE**  
**INFINITELY BETTER QUALITY**

## 9 Blue Prints - Data Book - Direction Book Now \$5

Increased demand for Stenode Data Book, Instruction Book and Blue Prints permits our cutting former price in half. Those who have already sent in full price will receive our check for \$5. We are not interested in making profit from our engineering service. Our profits come solely from Royalties paid us by our licensees.

**GERNSBACK PUBLICATIONS, Inc.**  
98 Park Place, New York, N. Y.

Enclosed find  Money Order,  Check, for \$..... Please forward me  STENOTUBE,  BLUE PRINTS, DATA BOOK and DIRECTION BOOK for building STENODE.  
(Make all checks payable to Gernsback Publications, Inc.)

Name .....

Street .....

City ..... State .....

The STENODE opens up new fields for short-wave and television work, as well as broadcasting. Full details of all sorts of applications are given in the STENODE Data Book. Nine full-sized diagrams show where to place every part. How to make every connection is clearly told in STENODE Book of Directions. Your finished STENODE will put you into a new field of radio. Fill in and mail the coupon with your money order for the biggest value ever offered custom set builders.

**STENODE CORP. OF AMERICA**  
GERNSBACK PUBLICATIONS, Inc.  
98 Park Place New York, N. Y.  
**SOLE SELLING AGENTS**

**IF IT ISN'T A STENODE IT ISN'T A MODERN RECEIVER**





“Takes the Resistance Out of Radio”

Editorial Offices, 96-98 Park Place, New York, N. Y.

# Fourteen Million Radios in U. S.

By HUGO GERNSBACK

**I**N figures recently published by the Census Bureau, which are reproduced herewith, the first nearly complete radio census of radio sets owned by listeners in the United States has been completed. The figures for the three States of Illinois, New York, and Pennsylvania have been estimated; and it may be assumed that the Census Bureau's figures of these three States are accurate enough to give an intelligent survey of the radio situation in this country.

It should be noted that the figure of 12,563,737 sets is given as of April 1, 1930. It is fair to assume that, between that date and January 1, 1932, the number will have increased to 14,000,000 sets in actual use at this latter date. This is a very conservative estimate, due consideration having been given the recent depression; if anything, the figure of 14,000,000 is too low, and a subsequent census will probably place the figure somewhat higher.

It should be noted that even the official figure, as of April 1, 1930, of twelve and one-half million radio sets in this country, places the United States far ahead of all the other countries in the world. From available figures, it would seem that the United States today has more radio sets in operation than all the rest of the world combined—a glowing testimonial to the progressiveness of Americans.

Taking the Bureau's estimate as to the average size of families in the United States, it would indicate that the potential listeners totalled on April 1, 1930, about 50,000,000, which is about 41% of the entire population. Of course, not all radio sets are operating simultaneously on any given day or night, but the figure is highly interesting; it may be pointed out that in a national emergency, for instance, better than half of the country can listen in to important

radio messages, if such should become necessary.

Naturally, the thought comes up immediately: “When will the saturation point of radio-set production be reached in this country?” The answer to that conundrum is, “Never.” There is no such thing as a saturation point in radio sets, any more than there is in automobiles. By the saturation point is meant the theoretical point where people will no longer buy radio sets.

This condition, of course, can never be reached, because radio sets are notorious for short-livedness; not because they wear out—quite to the contrary, they certainly last, physically, longer than automobiles—but because people insist upon having the latest and best sets; and that means that about every two or three years most of the sets in the United States will be replaced.

This progress, as far as can be seen at the present time, will go on indefinitely. New and better tubes, with great sensitivity and greater range, new inventions such as the screen-grid tube, the pentode, tone control, short-wave combination sets, noise elimination, etc., make radical changes in radio-set building necessary, and listeners sooner or later will want to have the latest and best set; not because their present receiver does not serve them well, but because they wish to be up-to-date.

With television in the offing, there is an added incentive for the purchase of different sets at a not

distant date.

But how many sets can this country absorb at any given time? It would seem that a figure of between nineteen and twenty million sets in the United States, during the next five years, is not an impossible one, and (given prosperous times) this estimate may easily be exceeded.

State	Radio Sets	Listeners (Estimated)
Alabama	56,191	251,210
Arizona	19,295	79,110
Arkansas	46,248	169,912
California	839,846	2,939,461
Colorado	191,376	495,396
Connecticut	213,821	876,666
Delaware	27,183	108,732
Dist. of Columbia	67,880	261,732
Florida	24,116	227,539
Georgia	61,998	292,086
Illinois	32,890	131,793
Indiana	71,113,597	1,578,388
Iowa	351,740	1,365,852
Iowa	309,237	996,021
Kansas	189,527	739,175
Kentucky	111,172	480,244
Louisiana	51,361	233,765
Maine	77,893	311,212
Maryland	156,165	657,153
Massachusetts	309,105	2,158,111
Michigan	309,196	2,158,791
Minnesota	287,880	1,298,086
Mississippi	27,175	109,543
Missouri	372,252	1,373,793
Montana	17,899	170,849
Nebraska	161,324	657,296
Nevada	7,869	27,152
New Hampshire	53,111	207,133
New Jersey	625,639	2,567,120
New Mexico	11,101	49,937
New York	*1,866,298	7,511,832
North Carolina	72,329	354,112
North Dakota	39,352	278,351
Ohio	846,767	3,161,991
Oklahoma	121,973	512,287
Oregon	116,299	418,676
Pennsylvania	*1,111,704	5,778,816
Rhode Island	91,791	397,297
South Carolina	28,007	131,130
South Dakota	71,361	306,952
Tennessee	86,229	371,997
Texas	257,686	1,082,281
Utah	47,729	210,008
Vermont	39,913	179,672
Virginia	96,539	411,217
Washington	189,229	668,847
West Virginia	87,169	402,357
Wisconsin	361,425	1,491,143
Wyoming	19,182	75,980
United States	12,563,737	59,186,191

\*Estimated.

Radio Sets in U. S. A. April 1, 1930

110V., A.C.  
OR  
6V., D.C.

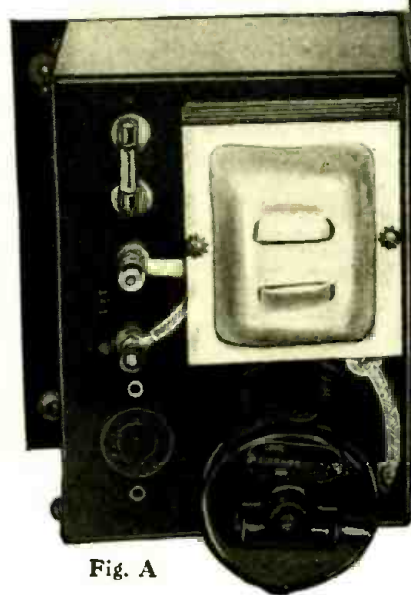

Fig. A



# The AUTOVERTER

*An Entirely New Idea in Portable Radio Set Operation*

By  
R. D. WASHBURN

**N**EWEST among the additions to the growing line of radio devices is a portable radio set designed to operate under widely varying conditions of location and current supply. This is the Radiette Autoverter and Model 30 Troubadour illustrated in Fig. A, left and right respectively; automotive '36, '37 and '38 tubes are used. The schematic circuit is Fig. 1. A rear view of the receiver chassis is Fig. B. An interior view of the converter unit is shown in Fig. C.

The receiver chassis is designed as a completely self-contained A.C. set, and is readily put into operation in a hotel room, at home, etc., merely by plugging into a 110 volt A.C. outlet the connection-cord with which the chassis is equipped; one end of this cord has a 2-prong plug for the light-line connection, and the other has a 5-prong plug for connection to a receptacle in the chassis. The receiver chassis measures 12 x 15 x 6 inches deep and weighs only 17½ lbs. "Parallel" pentodes are used in the output circuit, which feeds a midget dynamic reproducer.

For automotive operation, or wherever the only power supply available is a 6-volt storage battery, one additional unit will be required, an "autoverter." This is a mechanism for interrupting a circuit which includes the 6-volt supply and the primary of a special power transformer; the sec-

ondary of the latter supplies the necessary high potential which, rectified by the rectifier tube (a type 71A tube, with grid and plate connected together) in the receiver chassis, supplies the plate potential for the entire receiver chassis.

When the storage battery is used as the power supply, it is necessary to use a special cable to inter-connect the autoverter and the receiver chassis. This cable has a 5-prong plug on one end, to fit into the receptacle in the receiver chassis, and a 5-prong plug on the other to fit into the autoverter. The circuit thus made includes operation of the receiver tube filaments directly from the storage battery.

## Principle of Operation

This method of obtaining 110 volts from a 6-volt supply was described in the July, 1930 issue of RADIO-CRAFT in the article entitled "Obtaining 'B' power from a Storage Battery." However, mechanical and electrical improvements have been incorporated in the Autoverter. For instance, a centrifugal switch, which may be clearly seen at the right of Fig. C, operates to keep the trans-

*(Continued on page 424)*

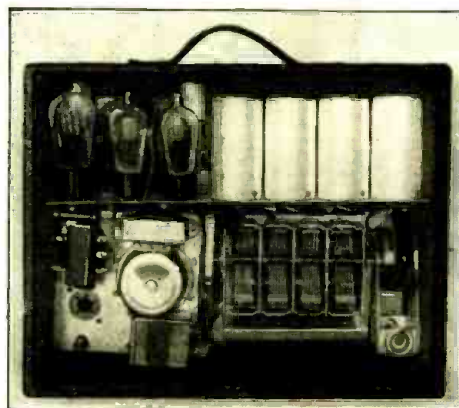

Fig. B

*Rear view of the Radiette Model 30  
"Troubadour."*



# RADIO RECEPTION

## ON HORSE BACK

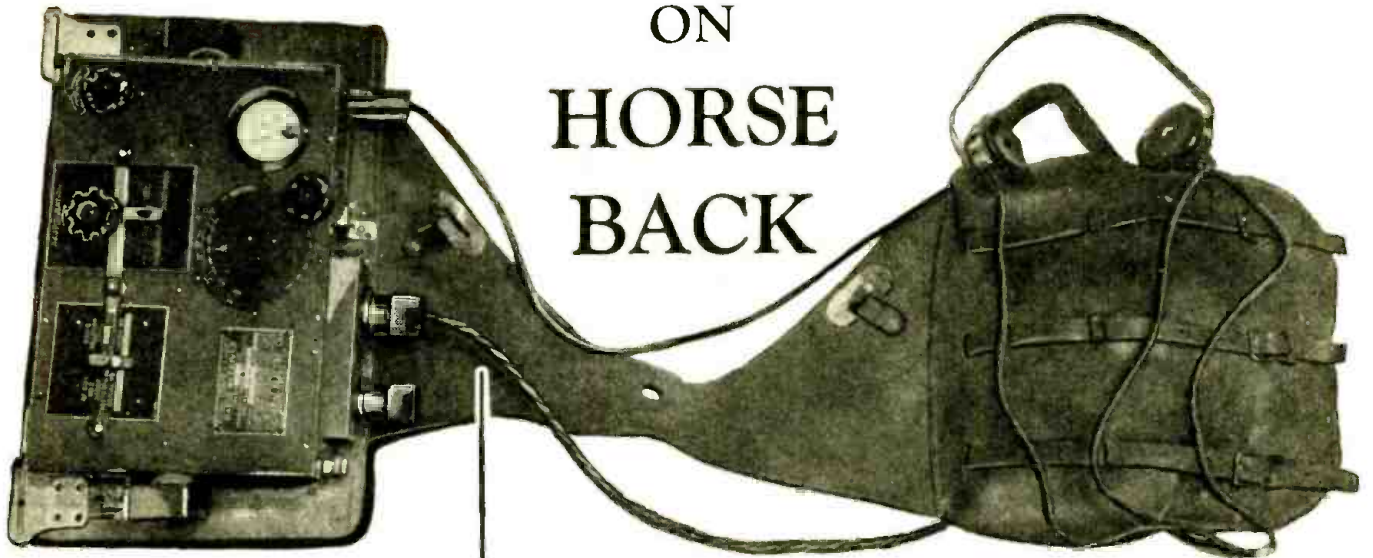

By  
**LOUIS MARTIN**

Fig. A  
(above)

*Above is a close-up view of the "radio saddle pack," otherwise known as the SCR-152 Radio Receiver. Its range is 400 to 850 kc. (350 to 750 meters). This illustration of the pack shows the tuner in an inverted position, since in use it mounts most conveniently on the left flank of the horse, as shown in the center panel. The only ground effect is that which results from capacity coupling. Perhaps cavalry manoeuvres in the future will be executed without a visible commander.*

Fig. B  
(below)

**T**HE crime wave that has swept the country during the past few years has been instrumental in causing Federal, State, City and County officials to equip all departments engaged in crime-detection work with radio transmitting and receiving apparatus. This type of apparatus has been installed in both permanent and portable locations, and has well justified its use. Officials, however, may well borrow a tip from the ever-alert Signal Corps of the U. S. Army, which has equipped Southwestern cavalry units, stationed at Fort Sam Houston, Texas, with radio so as to enable direct communication between cavalrymen and field commander.

### The Receiver

The receiver, shown in Fig. A, which is inverted (as can be seen by referring to Fig. B) to provide ease of tuning and short battery-connections, is mounted on a piece of sponge rubber. This in turn is securely fastened to the receiver mounting strip of stiff leather and the whole riveted on one side of the saddle pocket. A canvas belt is used to prevent the leather strip, on which the receiver is mounted, and the remaining saddle pocket, which contains the batteries, from bouncing against the horse.

When in operation, no direct ground is used, as it has been found that the capacity existing between the metal case of the receiver and the side of the horse is sufficient to give satisfactory pick-up.

The receiver itself consists of one tuned and one untuned stage of R.F., a regenerative detector, and two stages of A.F. amplification; special non-microphonic tubes are used. It has a frequency range of 400 kc. to 850 kc. (350-750 meters) being designed to receive signals from Signal Corps SCR-127 and SCR-130 transmitters. All connections, including those to the batteries,



are well soldered to prevent interrupted reception due to faulty connections which may result from the extreme vibration that the unit receives while the horse is in motion. The transmitters are designed for radio communication between mounted organizations and are of the master-oscillator, power-amplifier type. They use one 5-watt VT2 tube as an oscillator and three such tubes as power amplifiers and have a positive day range of 60 miles.

### Transmitter Power Supply

As for power supply, these transmitters use either a dynamotor which supplies 250 milliamperes at 350 volts when used by organizations equipped with motor transportation facilities or a hand generator of like output, if required by mounted organizations acting alone.

As a receiving antenna for the "saddle-bag" receiver, a steel casting-rod, or a pike, wound spirally with insulated wire and mounted in one of the stirrups as shown in Fig. B, is used.

### Government Activities

Radio equipment of almost every description has been, and is being, designed by the U. S. Army. The novel receiving station described above is only one of the many interesting devices that are being used to increase the efficiency of the army. In the December issue of RADIO-CRAFT, there was published a description of a one-pound transmitter that is used by the army for meteorological observations.

As additional material concerning Signal Corps radio apparatus is secured, it will be published.



# NEW RADIO

The latest equipment is described for the

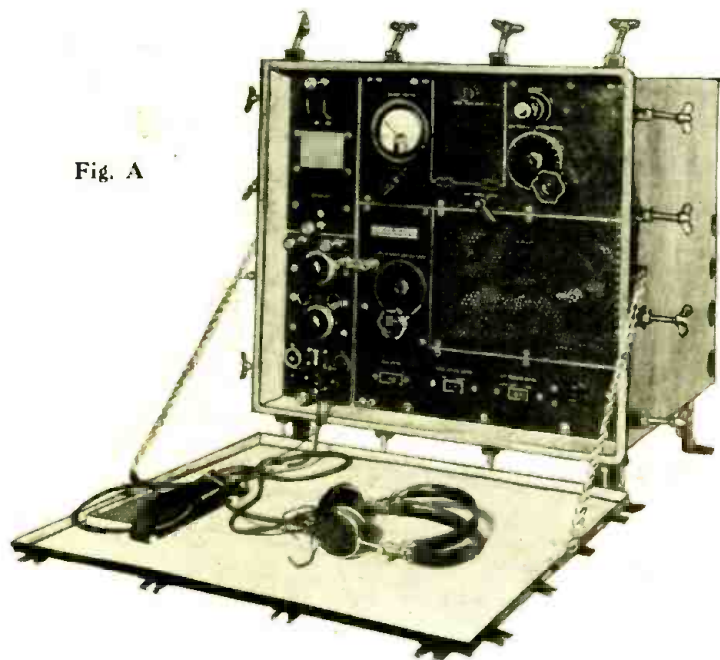

Fig. A

Lifeboat Model ET 3677 Radio Transmitter-Receiver.

## A LIFEBOAT RADIO SET

**I**N Fig. A is illustrated the newest thing in marine radio equipment: a radio set designed particularly for use in lifeboats, for emergency use.

A number of interesting features have been built into the design of this instrument. For instance, the storage batteries which power the unit are wired to the control panel in such manner that when the lifeboat is afloat the batteries may also be used to operate boat lights and a searchlight, and, by means of a key, to obtain code blinker operation. When the life boat is on deck, the panel provides a means of connecting the storage batteries with the ship's lines to keep them fully charged. Plate voltage is furnished by a motor-alternator.

Two-wave-band operation is available: 600 meters, for emergency calling, and about 50 meters, for general traffic. The maximum range at 600 meters is about 100 miles. The transmitter is rated at 15 watts. There are two tubes in the receiver, and two in the transmitter.

The instrument illustrated in Fig. A is the Model ET 3677 Lifeboat Transmitter-Receiver manufactured by the Radiomarine Corp. of America.

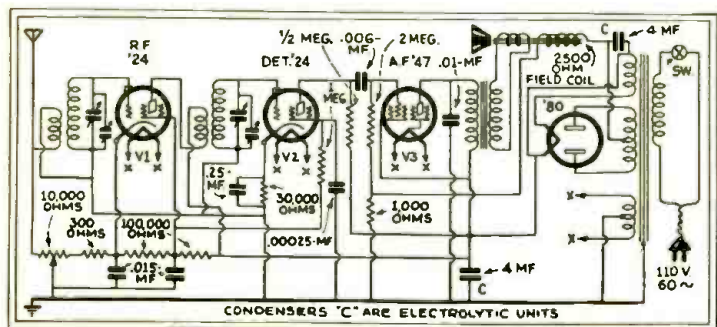

Fig. 2

Schematic circuit of the Peter Pan Model 84 Midget Set.

## SHORT-WAVE ADAPTER

**A**N interesting device known as the "Policer Short-Wave Adapter" is illustrated in Fig. B; its circuit connections are shown in Fig. 1. This device should interest the Service Man, because it offers a particularly convenient method of demonstrating the short-wave reception possibilities of a particular broadcast receiver in a given location.

This unit is applied to existing sets in the following manner: remove the detector tube, plug into the detector socket the correct adapter ("227" or "224"), plug the detector tube into the receptacle on the adapter, remove the antenna from its binding post on the broadcast set and connect it to the antenna post provided on the short-wave adapter,—and "go to it."

The single-turn antenna coil is wound over the secondary; alongside the latter is wound a tickler coil (10 turns, for the "227," and 24 for the "224"), all on a form 1 1/8 in. diameter. In Fig. 1, the adapter socket connections are shown as dots, and its plug connections as arrowheads; secondary S thus is tuned by the variable condenser in the broadcast set. The wavelength range covered is from 80 to 200 meters.

This adapter is manufactured by The Ralun Corporation.



Fig. B  
A Short-Wave Adapter.

## MODEL 84 PETER PAN MIDGET SET



Fig. C

The Peter Pan; it is only 12 in. high.

**O**NE of the very small radio receivers recently offered to the consumer trade is the Model 84 Peter Pan Midget Set, which is illustrated in Fig. C; its schematic circuit is Fig. 2. This circuit is designed to oscillate (with the volume control set at maximum) up to about 700 kc.

This chassis is designed for an antenna about 15 to 20 feet long; a ground connection ordinarily is not required. As shown, a convenient carrying case suggests the Peter Pan for use anywhere.

For the reference of Service Men, the following operating characteristics are given: Filament potential, V1, V2, V3, 2.2 volts; V4, 4.1 volts. Plate potential, V1, 200 volts; V2, 80 volts; V3, 190 volts. Screen-grid potential, V1, V2, 60 volts; V3, 200 volts. Cathode potential, V1, 1.5 volts; V2 5 volts. Control-grid potential, V3, 13 volts. Plate current, V1, 2.2 ma.; V2, 0.15-ma.; V3, 24 ma.

The Peter Pan, manufactured by Jackson-Bell Co., Ltd., weighs less than 10 lbs.

## METER FUSES

**T**O meet the demand for some form of protective device for meters, there has recently been put on the market a series of special fuses, one model of which, for 3-range meters, is illustrated in Fig. D. The trade name for these units is "Littlefuse."

They are glass enclosed and measure 1 x 1/4 in.; their ratings are 1/100, 1/32, 1/16, 1/8, 1/4, 3/8, 1/2, 1 and 2 amperes. In addition,

(Continued on page 426)



# EQUIPMENT

*trade, Service Man, and home-constructor.*

## THE AAA-1 DIAGNOMETER

By H. G. Cisin, M.E.

**S**KILL in locating radio troubles and speed in remedying them spell success for the radio Service Man. In radio work, however, both experience and aptitude must be augmented by suitable test instruments. This is obvious, but somehow many Service Men fail to realize the truth of this statement. Some try to "get by" with a miscellaneous collection of meters, while others shop around for the cheapest "set tester" on the market. Apparently, these men are blissfully unaware that trashy equipment will waste time instead of save it.

It takes good material to make a good service instrument. It also takes more than fine meters to turn out a real service instrument. Years of experience are required, and in addition, an intimate knowledge of the problems which are encountered by the Service Man. For after all, a service instrument which can merely perform a few standard tests does not fulfill its purpose, no matter how fine its meters or its case.

The original Supreme Diagonometer, placed on the market a number of years ago, was a fine piece of work and a splendid help to every Service Man who owned one. Recently, however, as a climax to years of developmental work, Supreme engineers have announced a new instrument—the AAA-1 Diagonometer—which is of the latest type in radio testing equipment. A front view is Fig. A; the interior, Fig. B; and the schematic circuit is Fig. 1 (this diagram appears on the following page).

This new device is so versatile, efficient, and accurate that it is really more than a testing instrument. It is the Service Man's "junior partner,"—always capable of tackling and solving any service job encountered, no matter how intricate. The design of the new Diagonometer is extremely flexible. It can be used to service the latest sets and the most obsolete ones. Superheterodynes, automobile sets, portables, midgets, power-operated or battery sets, are all the same to this instrument. Similarly, sets equipped with the newest tubes, such as variable-mu's or pentodes, can all be tested with this instrument. It will analyze circuits of every type including intermediate stages of "superhets," tuned R.F. circuits, resistance coupled amplifiers, power detectors, power pentode output stages, power supply circuits, etc.

### Five Important Testing Functions

The Diagonometer functions as an analyzer, a tube tester, a shielded oscillator, an ohmmeter, and a capacitor tester. These five major testing operations will each be described later. Inci-

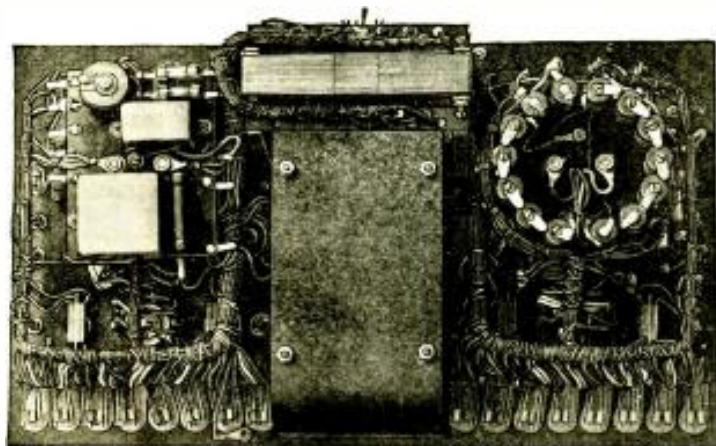

Fig. B

*Interior view of the latest Diagonometer.*



Fig. A

*A veritable portable laboratory; the Model AAA-1 Diagonometer.*

dentally, this instrument, although especially constructed for portable use, may also be mounted on a wall or in back of a test bench, by means of a special wall mounting. No matter how it is used, it comprises, solely within itself, a complete radio laboratory.

The analyzer circuits are designed to meet every radio-servicing requirement on all types of sets. Provision is made for reading plate currents of circuits and tubes under test without the manipulation of any current switches, at the same time testing the various voltages of other circuits terminating at the tube sockets. As a result, the high voltage circuits remain unbroken in all tests. In order to switch the meter from one analyzer plug circuit to another, it is merely necessary to press a non-locking push-button.

The Diagonometer can be used for an analytical A.C. voltage (1000 ohms-per-volt) test, up to 1000 volts on each side of a center-tapped plate supply transformer, through the rectifier tube socket. Provision is also made for the reading of the A.C. line voltage through the A.C. line supply cord, by means of a push-button. This arrangement eliminates the need for external connections in making this test.

A feature of considerable importance is the fact that all circuit analyses of the radio set may be made during the actual operation of the receiver, utilizing the power normally supplied, without disturbing any permanent connections of the set itself.

The analyzer plug, which is a part of the Diagonometer, has a five prong base; an improvement in design is the special snap catch which holds adapters until released. A simple adapter permits it to be used with four-prong sockets. A control-grid lug is attached to the analyzer plug by a flexible lead, which permits the operator to complete the control grid connections of screen-grid sockets, regardless of the make or type of the radio receiver. For the R.F. pentode tubes, a circuit is provided which terminates with the necessary terminal of the analyzer plug, so that this terminal may be connected to a suitable adapter for these tubes.

It would be impossible to enumerate in a short article all the different analytical tests which are possible simply by placing the analyzer plug in the radio set sockets and the tube in the analyzer load socket. A few of these readings are: direct current or alternating current filament voltage, screen-grid voltage, "C" bias volt-

*(Continued on page 427)*





# REPLACING THE TYPE '80 RECTIFIER WITH A MERCURY-VAPOR TUBE

A discussion of the advantages and the method of installing the new mercury-vapor rectifier.

By PAUL SCHWERIN\*

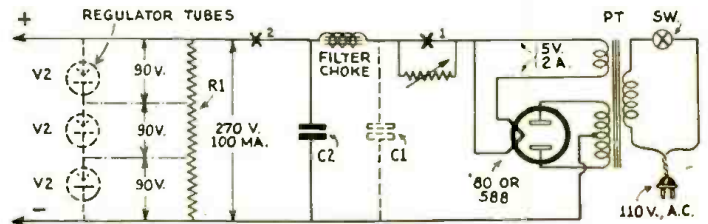

Fig. 1

A number of variations in power pack design are indicated in the above illustration.

EVERY Service Man and the users of the ordinary types of vacuum tubes are, in general, fairly familiar with their behavior, and it is by a comparison between the well-known types of tubes and the gas-filled types that we may become more familiar with the latter. The Perryman PR 588 tube is a rectifier containing mercury vapor and, therefore, belongs to the latter class.

It is suggested that the reader refresh his memory concerning this new type of tube, by reference to the article, "New Types of Receiving Tubes—A Mercury-Vapor Rectifier," which appeared on page 686 of the May 1931 issue of RADIO-CRAFT.

From the Service Man's standpoint, the Perryman type PR 588 tubes were designed to reduce the tube losses incident to rectification and, by increasing the power available, to make more flexible the standard full-wave rectifier circuit. Incidentally, the voltage regulation in a receiving set is greatly improved by virtue of the fact that the current remains practically constant with considerable variations in voltage.

Accordingly, the insertion of a PR 588 tube into circuits designed for the standard type '80 tube will result in an increased voltage at the receiver terminals, higher current flow in the filter circuits, and a higher voltage across the filter condensers.

It is obvious that some judgment should be exercised in replacing a type '80 tube with a PR 588 tube for this very reason; as in some receivers the increased voltage and current may be troublesome, due to low current-carrying capacity or other shortcomings.

Therefore, the PR 588 tube should not be inserted indiscriminately into sockets designed for the '80. The problems involved in the installation and the service on the PR 588 tube are exactly the same as those pertaining to the regular '80 tube. The tube has been very conservatively designed and, when used under normal conditions, will give at least as long a life as the standard '80 tube.

### Characteristics of Gas-filled Tubes

The utility of high-vacuum devices, their inherent stability, the high degree of development which they have reached, have re-

sulted in a large measure in obscuring many of the advantages of gas devices.

The characteristics of a high vacuum device which are outstanding are: the absence of gas ionization; cathode temperature not increased by discharge; no blue glow or visible evidence of discharge; three-halves power relation of current to voltage.

The gas-filled tubes differ as follows: gas ionization is present and is made use of in reducing the effect of space charge; the cathode temperature increases with an increase in the discharge current; a blue glow (or other color) is a visible evidence of discharge; the three-halves power relation of current to voltage is not obtained.

A consideration of these two classifications of features shows that the two devices are scarcely comparable. However, the characteristics of the latter type tubes are particularly applicable to rectification.

The curves reproduced as Fig. 2 on page 686 of the May 1931 issue of RADIO-CRAFT show the relation of the plate voltage to the plate current. It will be noted that in a case of the vacuum type rectifier an increasing loss in voltage occurs as the current taken from the rectifier increases. This, of course, is due to the fact that the internal impedance of the tube is greater, due to the space-charge effect which surrounds the filament and prevents the ready evaporation of electrons.

The same curve shows the plate voltage—plate current relationship in the mercury type, and it will be noted here that as soon as the potential reaches a value exceeding 15 to 17 volts, an almost straight upward trend of current results; as a matter of fact, we find that the voltage remains constant for all loads between 20 to 300 milliamperes. This effect is highly desirable, and means that the power loss in the tube is constant after once exceeding the ionization

(Continued on page 428)

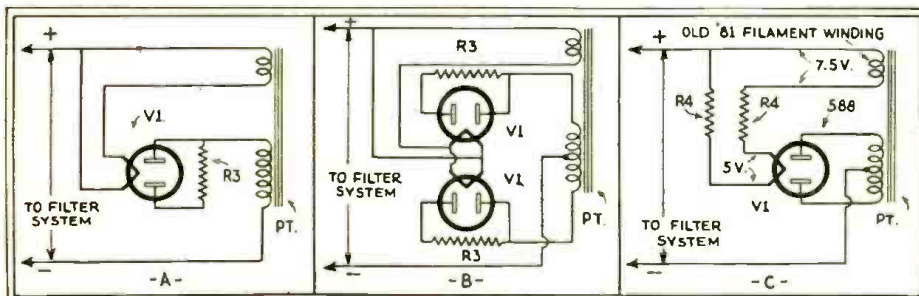

Fig. 2

At A, resistor R3 is used to balance the plate currents in the 588 rectifier; at B, the balancing resistors are indicated for full-wave rectification; and at C, the resistors R4 are used to lower the filament voltage.

# The Telepiano

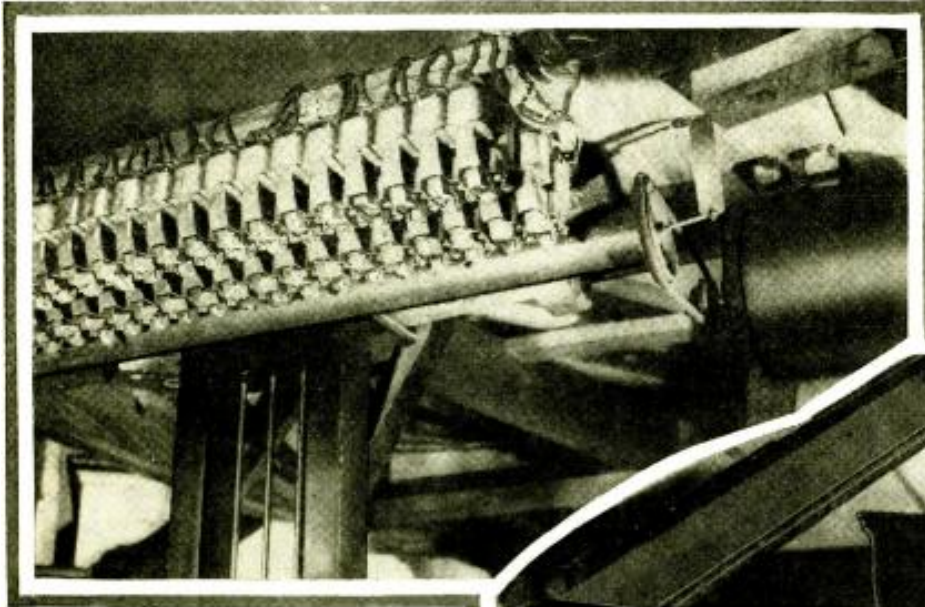

Fig. A

Above. An under-view of the mechanism.

EVER since the advent of radio broadcasting, the home use of musical instruments, especially the piano, has been on the decline; the result is that now, more than ever before, radio has become more or less indispensable as a medium of entertainment. Some people still regard the art of playing the piano as an accomplishment, while, at the same time, the thought of practicing for years in order to play it well has caused many people to abandon this means of entertainment since the radio is well able to satisfy them.

Mr. Glenn W. Watson of Detroit, an inventor, has succeeded in designing a device which enables a piano to be played by radio, thus bringing together two of the most popular mediums of entertainment. It is now possible for an artist to play a piano in the studio of a broadcast station, and have, throughout the country, every piano that is equipped with the Telepiano play in exact synchronism with the artist at the studio. It becomes fairly easy then, to follow the artist and, consequently, piano lessons may be given over the "air", one teacher serving for almost any number of students.

The Telepiano, Fig. A, may be conveniently mounted in any existing piano in one-half hour and will occupy an unnoticeable position, as shown in the figure.

## Method of Operation

The principle of operation is similar to the Watsongraph, also invented by Mr. Watson, and described in the August 1931 issue of *RADIO-CRAFT*.

Briefly, the transmitter mechanism, Fig. 1, consists of a set of contacts arranged in the form of a circle with an arm rotating around and making contact with each segment in succession. When a key corresponding to a certain note on the piano is depressed, a condenser charges instantly and



Fig. B

Above. The Telepiano in action.

discharges only when the rotating arm has made contact with a certain segment which corresponds to the key that is being depressed. This condenser discharge takes place through a relay winding which actuates a lever, sending a pulse to the radio transmitter.

The receiving circuit, Fig. 2, is equipped with a similar set of contacts. The pulse is received by the radio set, detected and amplified, and then fed into a set of thyatron relays. When the rotating arm on the commutator in the receiver makes contact with a certain segment, the pulse actuates a piano key (through another set of solenoids) corresponding to the key being depressed at the transmitting studio.

In order to make the receiving key stay down exactly as long as the sending key does, (Continued on page 432)

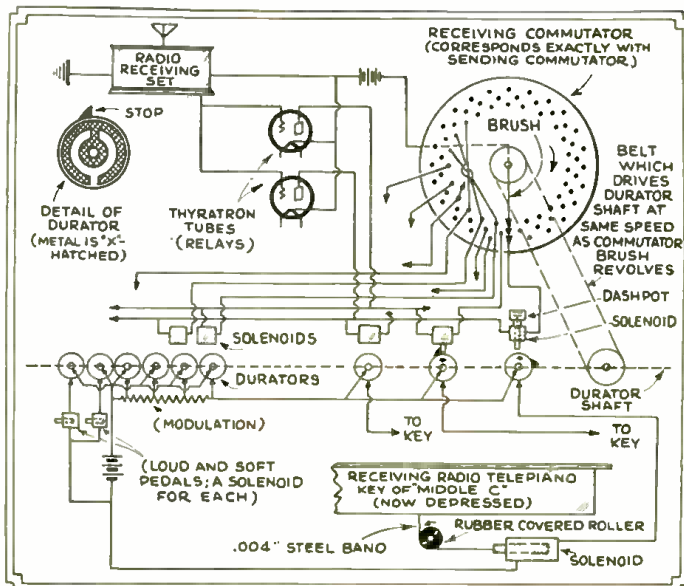

Fig. 2

A wiring diagram of the Telepiano. A commutator is used which enables the receiving piano to play in synchronism with the transmitting piano.



# Servicing DIRECT - COUPLED AMPLIFIERS

*Modern radio service calls for an extensive knowledge not only of advanced radio theory but also of the most efficient manner of attacking a problem. The author discusses practical amplifier servicing.*

**T**HE "direct-coupled" or Loftin-White type of audio amplifier, because of its low cost and high efficiency, enjoys widespread popularity with set builders, experimenters and manufacturers. Thousands of these are in use as phonograph amplifiers, speech amplifiers, and audio amplifiers for midget sets. The circuit is a radical departure from ordinary design, and presents a difficult job to the set builder or Service Man who is up against a balky specimen for the first time. With the desire to aid those who have had such difficulties, the experience of many months in building and servicing these amplifiers has been set down in these notes. One circuit, to which we will refer in this article, is shown in Fig. 1; others have appeared in past issues of *RADIO-CRAFT*.

By **SIDNEY FISHBERG**

In the first place, all parts to be used in the amplifier should be carefully tested before being used. All resistors should be within 10% of their nominal values. Condensers should be within 20% of their nominal values, and should have a high insulation resistance. As leaky condensers are a prolific source of trouble in this amplifier, only the highest quality units should be used.

### Test Procedure

When the amplifier is assembled and found to be inoperative, or when a good amplifier becomes inoperative, a particular service procedure should be followed. (All the tests in this procedure may be made with but one instrument, a 0-300-volt ohmmeter with a resistance of 1000 ohms per volt.) These directions apply specifically to the '45 amplifier shown in Fig. 1, but may be used with suitable changes for pentode or '50 Loftin-White amplifiers.

If the amplifier is absolutely dead, check the loud-speaker and the speaker transformer. If these are in good condition, the trouble lies in condenser C2 or the '45 filament winding of the power transformer. Measure the voltage between points 5 and 7 of Fig. 1, and between points 1 and 5. If the former voltage is very low, or even zero, while the latter is abnormally high (see "Normal Voltages," below) this is an indication of a grounded '45 filament winding or a shorted or leaky by-pass condenser C2. The fault may be traced by disconnecting the leads from the '45 filament winding and testing for a short to ground. If this is the case, the transformer should be replaced. If the transformer checks O.K., the resistance of condenser C2 should be measured. If it is found to be shorted or leaky, it should be replaced.

If the amplifier sounds "alive," vary the hum-bucking potentiometer P, and notice if the hum varies in intensity, or stays constant; also, whether or not there is any motor-boating. If the hum is accompanied by vigorous motor-boating at a period of approximately 150 cycles, and the voltage across the 50,000-ohm grid bias resistor is only half its normal value, this is an indication that the input leads are open. These should then be checked for continuity, and an examination made of the input device (phonograph pick-up or transformer).

### Lack of Sound

If the hum-bucking potentiometer does not affect the hum level, and a phonograph pick-up gives no reproduction whatsoever,

a grounded hum-bucking potentiometer is indicated. Other symptoms of this fault are no voltage between points 1 and 2, and abnormally high voltage (7 to 15 volts) between points cathode and 2. The remedy is obvious,—re-center the potentiometer in its mounting hole and see that the insulating washers are in a correct position.

If the variation of the hum-bucking potentiometer gives some change in hum intensity but no satisfactory minimum point, and if reproduction is distorted or entirely lacking, these are indica-

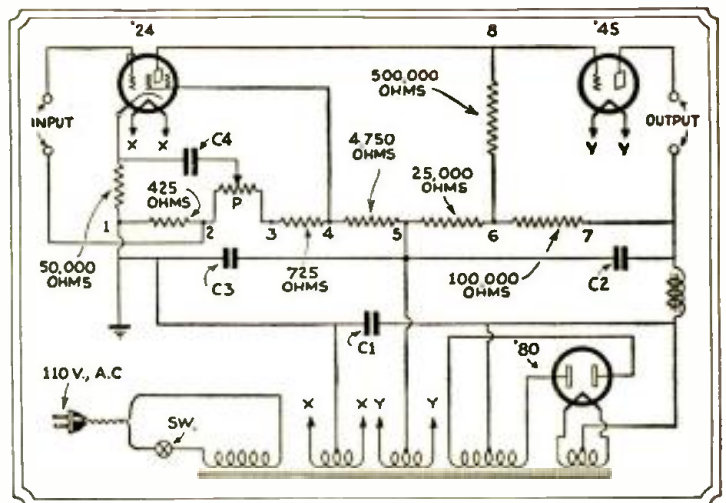

Fig. 1

Schematic circuit of a representative direct-coupled amplifier. Voltages are read in reference to numbered positions.

tions of some condenser or resistor being defective. Measure the voltage between points 5 and 7. If this potential is considerably below 250 volts, while the rest of the circuit is normal, a leaky hum-bucking condenser C1, or a defective grid bias resistor is indicated.

A leaky hum-bucking condenser may be detected by measuring the resistance between screen-grid and cathode of the '24 tube. If this resistance is found to be less than 50,000 ohms, it is conclusive proof that the hum-bucking condenser is leaky or shorted, and requires replacement.

A defective grid bias resistor may be detected by measuring the voltage across its ends. If this potential lies outside the range of 8 to 12 volts, the resistor is off-value and should be replaced. The best scheme is to place in the circuit a variable resistor of high value and vary it until the plate voltage of the power tube is restored to its normal value. A correct value of fixed resistor, as indicated by ohmmeter measurement of the variable unit, may then be substituted for the variable resistor.

(Continued on page 428)

# SELECTIVITY

## A Frank Discussion of the Advantages to be Gained By the Use of Sharply Tuned Circuits

By C. H. W. NASON

**F**OR some reason or other, the radio public seems to be in a quandary regarding the question of selectivity.

One year it is led to believe that selectivity is accompanied by poor quality, and the next year, the same "authorities" claim that selectivity and quality go hand in hand; the result being that the radio public does not know whom to believe. What may be selectivity in one sense may not be selectivity in another. This differentiation has been discussed in various technical journals, but authors do not seem to take it upon themselves to clarify the situation for either the Service Man or the public in general.

As we shall soon see, a circuit may be selective and result in the cutting off of the side bands, giving us poor quality. If we attempt to lower the selectivity to obviate this difficulty, then the effects of interfering stations would so distort the ultimate signal as to produce results which are not as good as that obtained with a highly selective circuit.

### Numeric Selectivity

Both mathematically and practically a modulated signal can be analyzed into three components having frequencies of  $F$  (the carrier frequency),  $F$  minus  $f_m$ , and  $F$  plus  $f_m$  (where  $f_m$  is the frequency of modulation). It stands to reason then, that a circuit tuned to the frequency of the carrier and yet so selective as not to pass the other two frequencies equally well, will have the effect of suppressing the received modulation frequencies. It is also evident that a circuit of such nature will pass signals modulated at low frequencies better than those modulated at high frequencies.

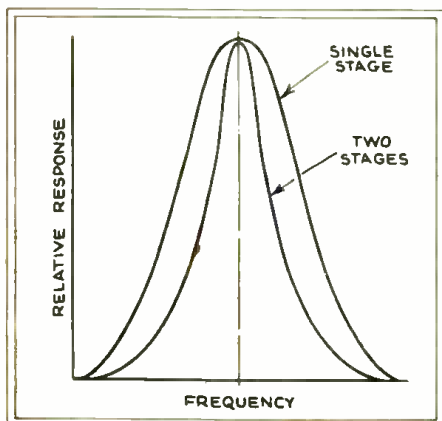

Fig. 3

The response of a signal after it passes through two tuned stages. Note the high-frequency cut-off.

If a signal frequency of 1000 kc. is modulated at 5000 cycles a circuit must pass all frequencies from 995 to 1005 kc. without fail if the original characteristics of the modulated wave are to be retained.

In Fig. 1 is shown the transmission characteristic of a sharply tuned circuit in comparison with an ideal characteristic which takes a rectangular form. As we increase the number of tuned circuits employed in a given system, the selectivity is also increased. For example, if in passing through a single circuit, all frequencies a given number of cycles off that to which the circuit is tuned, are cut down to 90% of their ideal response, the passage through two circuits will result in a further reduction in output to 81% of that obtained at the resonant frequency. Passage through three circuits will result in the response at the off signal frequency being about 73% of the response at the resonant frequency. This is shown in Fig. 3.

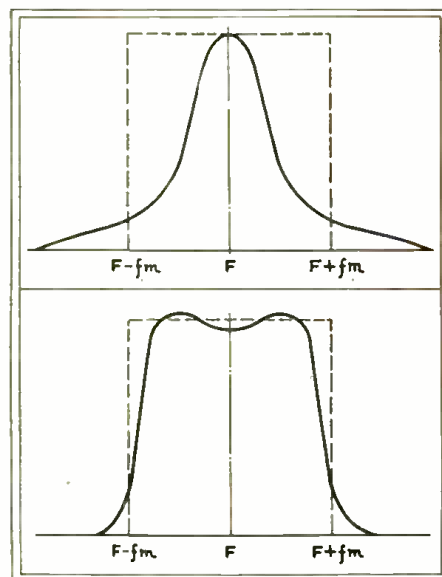

Fig. 1

Above. Ideal and "skirt" response curves.

Fig. 2

Below. Comparison of ideal and actual band-pass response.

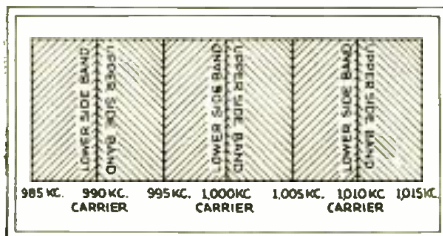

Fig. 4

Since the carriers of each station are separated by 10 kc., the entire broadcast band is utilized.

The selectivity of a tuned circuit is determined by the relation between inductance and resistance in the circuit, and a factor of merit "Q" is obtained by the equation  $Q = \frac{L}{R}$ , where  $F$  is the frequency;

$Q = \frac{L}{R}$ , where  $F$  is the frequency;

$L$ , the inductance; and  $R$ , the resistance of the coil. This type of selectivity is known as the *numeric selectivity* of a circuit and "Q" is determined experimentally by measuring the current produced in a circuit by a given signal when it is tuned to resonance, and comparing this reading with the current obtained when the input signal is a given percentage off resonance.

### High Numeric Selectivity in Supers

In the modern superheterodyne receiver, the incoming signal "beats" against a local oscillation of such a frequency as to produce a resultant signal of 175 kc. which

can be more readily amplified at high gain. Not only is the amplification more favorable due to the transposition to the lower frequency prior to amplification, but the selectivity is also enhanced.

With our circuits tuned to an incoming signal of 1000 kc., an interfering carrier at 1010 kc. is removed by 1% from the desired signal. Mixing the incoming signal with an oscillator operating at 1175 kc. produces a 175 kc. beat which is then amplified. The interfering signal produces a beat of 165 kc.—still differing by 10 kc. from the frequency to which the I.F. circuits are tuned, but removed from the resonant frequency of 175 kc. by 5.7%. Inasmuch as the percentage off resonance has a great deal to do with our primary measurement of selectivity, it is not difficult to see that a distinct gain in numeric selectivity has been achieved.

### Adjacent Channel Selectivity

It was obvious in Fig. 1, that if a high numeric selectivity were employed, the higher frequencies of modulation would suffer. This loss in high frequencies is also increased by the use of the superheterodyne arrangement because of its high numeric selectivity. Stations in this enlightened country are blessedly operating by law in  
(Continued on page 429)



# A NEW SYSTEM OF STATIC REDUCTION

By HENRI F. DALPAYRAT

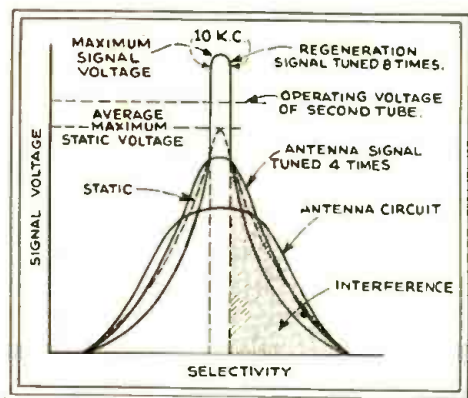

Fig. 2

This graph illustrates Mr. Dalpayrat's system.

**M**OST static reducers are based upon the principle of "bucking" static against static and, by means of special filter circuits, isolating the remaining or broadcast signal. These neutralization systems actually reduce static interference an appreciable degree. The circuits, however, are very difficult to adjust (to obtain complete neutralization) and they may be efficient only at certain frequencies.

The writer believes that he has solved the problem of static reduction in a simple and satisfactory manner, without any of the above mentioned objections or limitations. The circuit used in experimental models is shown in Fig. 1.

The desired signal is selected from the antenna circuit by the resonant circuit C1, S1. Successive tuned circuits S2, S3, S4 are coupled together in cascade by small capacities, C5, C6, and the inductive coupling of P4 and S4. The coupling between these circuits being rather tight, the transfer of energy is approximately in the order of 1-to-1 ratio; the only stepping-up action taking place in the total circuit being between P1 and S1, and between P4 and S4. With a circuit of this design the tuning is not excessively sharp; thus the precious sidebands containing the overtones and higher

frequencies in a radio signal are not attenuated.

The incoming or signal frequency, tuned by the four circuits, is amplified by tube V1. Tube V2 has its grid circuit connected in parallel with V1 through coupling capacity C7.

Tube V2 is highly biased so as to be rendered inoperative to signal intensities of the order of those in the aerial circuit. However, as soon as the signal is regenerated in the aerial it is re-tuned and again regenerated an incredible number of times in a fraction of a second. During this regenerative re-tuning process much of the aperiodic static is filtered out and grounded while the strength of the desired signal, which has a sine-wave form, is increased. This condition is clearly illustrated in a graph, Fig. 2, which is based on theoretical values.

By adjusting the "C" bias of V2 at R2, and the regeneration of V1 at R1, it is possible to find a certain relation between those two functions so that V2 will only be sensitive above a certain value of voltage and increasing the regeneration of V1 will raise the signal voltage to that value.

By looking at the curves of Fig. 2, it is easy to understand the mode of operation of this system, which is based entirely on a principle of *intensity differentiation*. The operating voltage of V2 being raised above the static average maximum voltage, it will only operate on the highest voltage, (this is only possible provided that the static reaching V1 is not stronger than the signal); this system is about 80% efficient.

To duplicate the schematic circuit, Fig. 1, the following parts will be required:

(Continued on page 436)

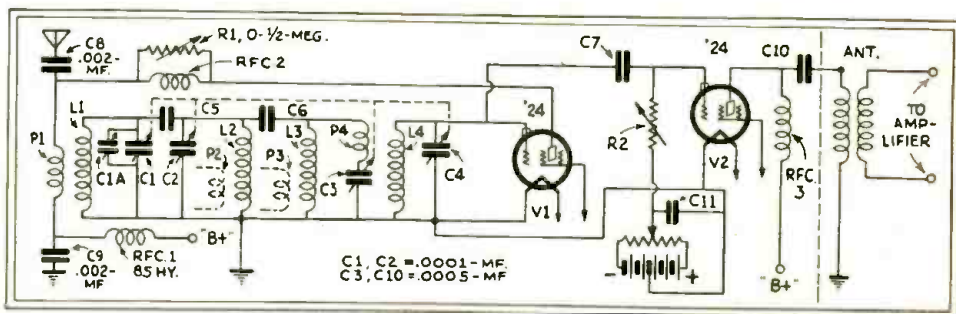

Fig. 1

Schematic circuit of Mr. Dalpayrat's system of static reduction by intensity differentiation. Experimenters may use any available equipment having the specified values.

## TIME AND THE RADIO SERVICE MAN

**I**N figuring out the amount which should be charged for a service job, it is necessary to take into account labor, materials, overhead, and a reasonable profit.

The importance of the *time element* in labor is obvious. Time also enters into the cost of materials, since time is required in purchasing them and in bringing them to the place where they are to be used. The factor of time also enters into the amount of overhead chargeable to any particular job; if one job takes twice as long to complete as another, it is self-evident that it should be charged with double the overhead.

Spending unnecessary time on a servicing job, therefore, increases the cost to the customer and at the same time decreases the Service Man's profit and prestige. Saving time reduces all costs, permitting the Service Man to charge less and still to make a larger profit.

Realizing these facts, Electrad engineers have devised several types of replacement equipment to enable the Service Man to save time. For example, they have pro-

duced a single volume control which can be used in 133 different commercial radio receivers. Through ingenious design, a total of five different Electrad replacement volume controls can be applied to more than 343 commercial receivers. Seven additional controls take care of almost all other volume control requirements.

The design of the new Electrad replacement controls is so flexible, that they will take care of the very latest sets containing variable-mu tubes, pentodes, etc. As a result, the Service Man who carries just these few controls in his kit, is sure of being able to replace a faulty volume control, without having to waste time going back to his shop after additional equipment.

At this point, mention should be made of the "Truvolt" type resistors, which are also designed to save time and money for the Service Man. These resistors are made in all standard sizes and resistance values and also in various required current-carrying capacities. They may be mounted anywhere. One or more patented sliding clips

may be added, removed, or adjusted to any position to obtain the exact voltages needed. Hence a few of these resistors in various capacities, and some extra sliding clips, may be used to perform a multiplicity of servicing jobs. (The unique open-air winding of these resistors insures cooler operation, longer life and more stable performance than could be obtained with any other apparatus.)

A comprehensive "Replacement Volume Control Guide" has recently been issued, which tells instantly which of the several volume controls should be used in replacing the control in any of 343 standard commercial receivers. Twenty different volume control hook-up diagrams are shown and the various makes of receivers are listed alphabetically. Each receiver is listed not only by name, but also by model number. The correct replacement volume control type number is then given, as well as the circuit diagram which applies in each instance.

This Guide may be obtained gratis from Electrad, Inc., 175 Varick Street, N. Y. C.

# Magic in Meters

(PART III)

This article by Mr. Denton on the subject of meters and their applications treats in detail the design of multipliers and shunts.

By CLIFFORD E. DENTON

THE D.C. and A.C. instruments discussed in Parts I and II of this series, and which appeared in the November and December issues of RADIO-CRAFT, form the nucleus of the development of modern service equipment.

When a meter is used to measure difference of potential, it is important that the current consumed by the meter be not so large as to appreciably increase the load of the circuit. If the current consumed by the voltmeter is large, the effect will be a reduction of the voltage being measured, with the result that the value indicated on the instrument is not the actual value of potential which is present when the meter is out of the circuit. Thus, the value of an instrument as a voltmeter is determined by the amount of current it consumes.

A convenient means of specifying the sensitivity of a voltmeter is by the number of ohms resistance for every volt in the meter.

This ohms-per-volt value of a D.C. meter is equal to the *total* resistance of the instrument divided by the *maximum* voltage indicated on the scale; or

$$\text{Ohms-per-volt} = \frac{\text{total resistance of meter}}{\text{maximum voltage}}$$

The total current consumed by a meter for full scale deflection is, therefore,

$$\text{Current} = \frac{1}{\text{Ohms-per-volt}} \text{ or } = \frac{1}{\text{total resistance of meter}}$$

If the range of a meter is to be extended, resistors (called multipliers) are added in series with the meter as indicated in Fig. 1. Referring to this figure, the multiplier  $R_m$  is in series with the voltmeter  $V$ , and the meter is shown shunted by a resistor  $R_v$  which represents the resistance of the meter. Letting  $E_1$  represent the normal range of the meter, and  $E_2$  the range desired, the value of  $R_m$  necessary to extend the range can be found by use of the following equation:

$$R_m = R_v \left( \frac{E_2}{E_1} - 1 \right)$$

For example: if  $E_1$  is 200 volts;  $R_v$ , 10,000 ohms; and  $E_2$ , 300 volts; then

$$R_m = 10,000 \times \left( \frac{300}{200} - 1 \right) = 10,000 \times 0.5 = 5,000 \text{ ohms.}$$

Since the above problem is a representative one, it would be necessary to add a 5,000-ohm resistor in series with the meter as a multiplier in order to extend its range to 300 volts. From the above, it can be seen that by the proper selection of multipliers, it is possible to extend the range of a voltmeter to any desired value. A group of resistors connected in series, as shown in Fig. 2, will enable the user to obtain the desired range by moving switch  $S$  to the proper tap.

It is sometimes desirable to know the reverse problem; that is, knowing the resistance of both the meter and its multiplier, how much its range has been extended.

The multiplying factor indicating the number of times the voltage scale of the meter has been increased is found by the ratio

$$\frac{R_v + R_m}{R_v}$$

Substituting the values in the example previously given, we have

$$\frac{10,000 + 5,000}{10,000} = 1.5$$

Therefore, any indication on the meter, with the multiplier in the circuit, should be multiplied by 1.5 to obtain the correct value of the voltage.

It is possible that the Service Man may not know the internal resistance of a meter. If such is the case it may be obtained by connecting the meter as shown in Fig. 3. Then, using ohm's law:

$$R_v = \frac{\text{voltage read on meter}}{\text{current read on milliammeter}}$$

If calibrated resistors of approximately the same value as the internal resistance of the meter are available, the half-scale deflection method may be used.

The procedure is simple. First, short-circuit resistor  $R$  in Fig. 4 and then apply sufficient voltage  $E$  to obtain a full-scale deflection. If the full-scale reading is 100 volts, apply 100 volts. Then increase  $R$  until the reading of the meter is exactly one-half full-scale. The value of resistance  $R$  then equals the resistance of the meter. This becomes evident from the fact that when resistors are in series, and equal in value, then the same current will flow through both of the resistors, and consequently the voltage drops across each of them will be the same.

### D.C. Ammeters and Shunts

There are many cases in which the current range of a milliammeter is too low for the conditions at hand. It is then necessary to increase its range by shunting some of the current around the meter, only permitting enough to pass through the

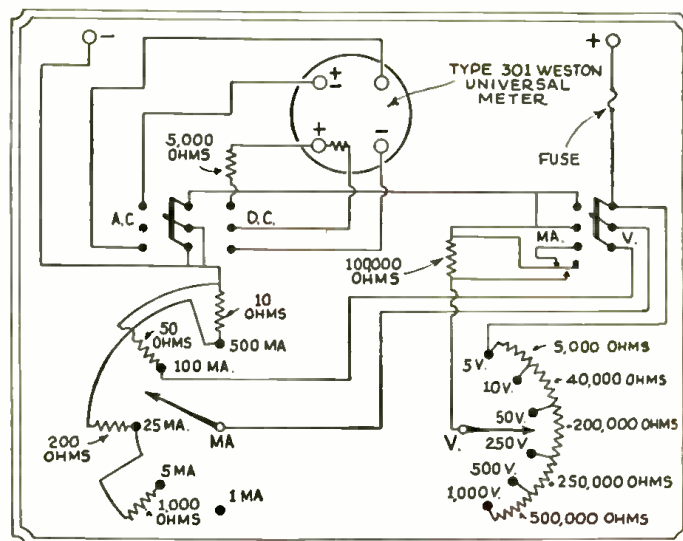

Fig. 12

Circuit diagram of a complete A.C.-D.C. voltmeter and milliammeter. All values are indicated on the diagram for the convenience of Service Men desiring to construct this universal meter. It is fully protected against burn-out by three separate and distinct means.



moving coil to actuate the pointer. This is indicated in Fig. 5, in which R1 represents the resistance of the meter A, and R2 the shunting resistor.

It is well to note at this time that current multipliers are always used in parallel with the instrument, while the voltage multipliers are always in series.

Any resistor placed in shunt will increase the range of the meter by the ratio

$$\frac{R2 + R1}{R1}$$

$$= \frac{R2}{R1} + 1$$

If a Weston 301 D.C. 0-1 milliammeter has a resistance of 27 ohms, then a shunting resistor of 27 ohms will increase its range by the factor 2, as can be seen by substituting numbers for the letters given in the formula above.

$$\frac{27 + 27}{27} = 2$$

(the ratio of the increase)

Thus the meter having a normal maximum reading of 1 milliamperes, will have its range doubled or extended to 2 milliamperes. Figs. 6A and 6B show two methods of shunt connections which are commonly used.

The average Service Man often finds that it is impossible to obtain resistors of low ohmic value of sufficient accuracy for use as shunts, consequently the following scheme should be used in such cases.

Referring to Fig. 7, R2 is the shunting resistor and R1 is one that is placed in series with meter A.

Now if the range of the D.C. Weston 0-1 milliammeter is to be extended to 1 ampere, and the internal resistance of the meter is 27 ohms, it would be necessary to increase its range 1,000 times, as shown by the formula

$$\frac{I2 \text{ (current range required)}}{I1 \text{ (current range of meter)}} = \frac{1}{.001} = 1,000.$$

This is a very high ratio, and when it becomes necessary to use a shunt that can carry 999 milliamperes while the meter carries only 1 milliamperes for full scale deflection, the shunt resistance will have a value of

$$R \text{ (shunt)} = \frac{R \text{ (meter)}}{(\text{factor of increase}) - 1} = \frac{27}{2 - 1} = 27 \text{ ohms.}$$

It is very difficult to obtain a resistor of 0.0273-ohm for this purpose and, therefore, the use of a resistor in series with the meter will enable us to use larger values of R2 which can be readily obtained.

Making R1 500 ohms with a meter resistance of 27 ohms, the total series resistance of this circuit becomes 527 ohms, and as the

$$\frac{527}{1,000}$$

ratio of increase is 1,000, then

$$\frac{1}{.001} = 1,000 \text{ (ratio of increase); and}$$

$$R = \frac{1027}{1,000} = 1.027 \text{ ohms.}$$

Here, a 1-ohm resistor for R2 and a 1,000-ohm resistor for R1, will work out very well for all general purposes. Surely the Service Man can obtain a 1 and a 1,000-ohm resistor with an accuracy of less than one per cent, whereas it would be impossible to obtain one of 0.027-ohm at all.

### Finding the Resistance of Ammeters

Many times there is no knowledge of the internal resistance of a milliammeter, and as it is necessary to know this value before a proper size of resistor can be selected for the shunt, several methods of determination are used.

The simplest way to find the resistance of the meter is by the half-scale deflection method; the connections for such a measurement being shown in Fig. 8.

with the instrument. Many use the milliammeter because of the simple additions necessary to give a satisfactory movement.

A Jewell Model "8" D.C. 0-1 milliammeter, Fig. 9, has a resistance of 30 ohms.

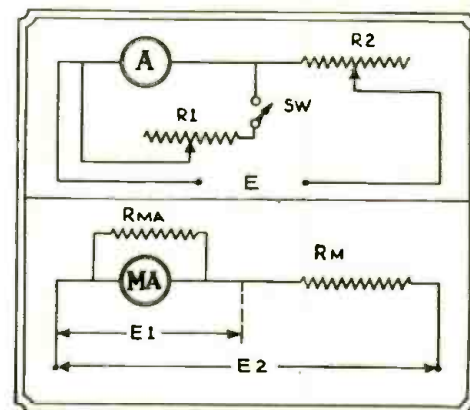

Fig. 8

Above. Determination of ammeter resistance by the "half-scale deflection" method.

Fig. 9

Below. A method of connecting a resistor to make a voltmeter from a milliammeter.

Therefore, a full scale deflection requires a voltage of 0.03-volt (E1). If a voltage range of 500 volts (E2) is desired, the range must be extended 16,666 times, and the necessary resistance value can be found thus:

$$Rm = Rma \left( \frac{E2}{E1} - 1 \right)$$

$$Rm = 30 \left( \frac{500}{.03} - 1 \right)$$

$$Rm = 30 \times 16,666$$

$$Rm = 499,980 \text{ ohms.}$$

If the voltages to be measured are high, the meter resistance can be ignored, but if the voltage range is lowered to the point where the measured voltage with the multiplier approaches the normal range of the meter without the multiplier, the percentage of error increases.

The chart shown on page 681 of the May 1931 issue of RADIO-CRAFT has the various values of resistors tabulated for use with various ranges of milliammeters and microammeters for all voltage ranges from 1 to 1,000 volts.

The use of low-current-consumption meters as voltmeters (consuming 1 milliamperes for full scale deflection) is convenient, and by ignoring the resistance of the meter, for all practical purposes,

$$R \text{ (multiplier)} = \frac{\text{maximum voltage range}}{\text{current through the meter}}$$

Fig. 10 shows a circuit by which voltage ranges of 10, 50, 100, 250 and 500 volts may be obtained with a sensitivity of 1,000 ohms-per-volt.

### A.C. Voltmeter Multipliers

The iron-vane types of A.C. instruments may also have their voltage ranges increased in the same manner as the D.C. instruments. The average A.C. meter has a much lower (Continued on page 434)

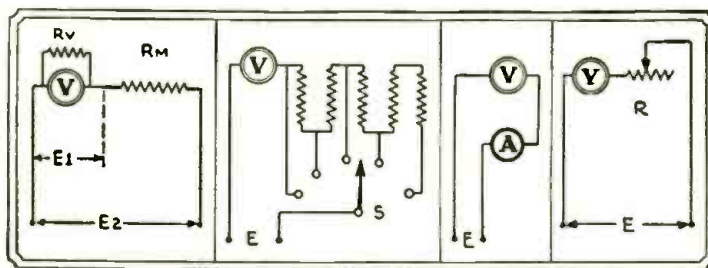

Fig. 1 Fig. 2 Fig. 3 Fig. 4

Left. The multiplier is connected in series with a voltmeter. Left-center. A means of connecting multipliers for selecting ranges. Right-center. One means for determining the resistance of a voltmeter. Right. "Half-scale deflection" method of determining voltmeter resistance.

R1 is a calibrated resistor and R2 a current-limiting resistor which is used to adjust the current through the meter A to full-scale deflection. With the meter reading at top mark, the switch SW is closed and R1 varied until the meter reads half scale. The resistance of the meter then equals the resistance of R1; and since R1 is calibrated, its value is easily obtained. The currents through the meter A and resistor R1 are equal. Consequently their resistances must be equal.

### D.C. Voltmeters from Milliammeters

Experimenters and Service Men are using milliammeters as voltmeters simply by adding a resistor in series

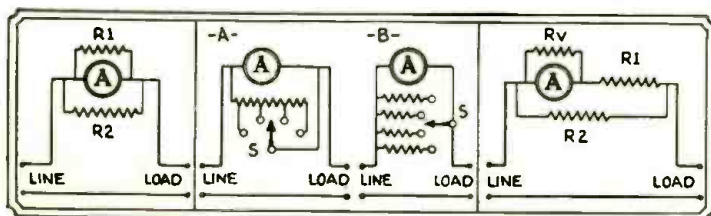

Fig. 5 Fig. 6 Fig. 7

Left. The shunt R2 is connected directly across the ammeter. Center. At A and B are shown two methods of connecting several shunts. Right. The resistor R1 is inserted in series with the meter to increase the size of shunt required.

# RUNNING THE SERVICE SHOP At a Profit

By HARRY GEORGES

SOME months ago, a progressive radio manufacturer formulated a plan not only to make his radio-service department pay for itself, but actually to make it show a profit—and it did.

This plan is not just a theory but has already gone through the "laboratory" and is now ready for field service. The "laboratory" consisted of service departments—from the one-man business to the highly-trained "100 men" organization, as in the automobile industry, the radio service department is of utmost importance.

The customer "sends for" the Service Man and anxiously awaits his arrival. Because of his superior knowledge of things pertaining to radio, the Service Man's recommendation goes a long way with the customer—he is the "radio doctor."

The modern "radio doctor" should not consider his work done after the set is repaired. He should guard against future trouble. Such service builds confidence, recommendations, and increased calls.

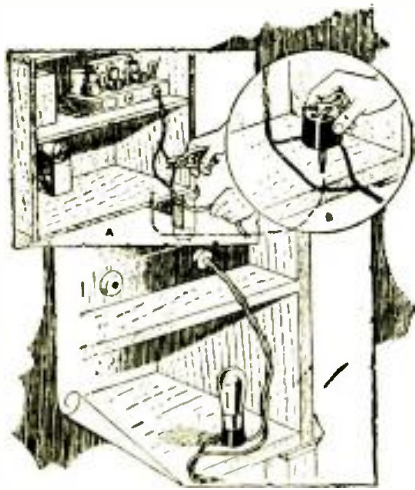

This illustration shows the ease with which an automatic line-voltage control may be added to any receiver.

After looking the set over, the Service Man usually finds a resistance, condenser, or tube which needs replacement. High voltage may have been the cause of the trouble—or just may have helped to make matters worse. At any rate, the set is repaired and a voltage regulator is connected in series with the power line—just to see how the set sounds on regulated voltage.

The new tube naturally arouses curiosity. The Amperite Plan even goes as far as to

provide a simple selling talk for the "Service-salesman." The talk runs like this:

"Oh yes, lots of radio troubles are due to voltage fluctuations that we cannot see. The voltage has a habit of jumping just when you are not checking it. And those jumps raise the devil with the tubes, power packs, and reception. This automatic regulator keeps the voltage along the straight and narrow path. Acts like a shock absorber on a car—decreases wear and tear. Well, if I have an extra one on hand, I will be glad to install it—and save you a service charge."

And thus, another automatic voltage regulator is readily sold, leaving the customer more contented, the dealer with a handsome profit and the Service Man with a worthwhile commission to add to his salary.

The new merchandising plan has proved to be exceptionally successful wherever it has been given a fair trial. One dealer has been averaging 28 automatic line-voltage controls per month for each Service Man—thus getting a net profit of \$37.80 per month per man. Perhaps the best way to show the advantages of this plan is to present actual facts and figures taken from the experience of a large New York radio concern. Early in January, 1931, Davega, Inc., of New York City, one of the largest radio chain stores in the country, decided to try out the plan. This concern specializes in the retailing of radio sets and sporting goods. It operates over twenty-eight retail establishments in the metropolitan territory. All radio servicing is handled through a central radio-service department—about 100 Service Men are employed.

## The Plan

In order to start the plan, a talk was given to the Service Men assembled at a special meeting. Three things were impressed upon the men. First, the need for automatic line-voltage control was illustrated and emphasized. Second, the men were shown the ease with which a sale could be made; and third, they were offered a cash incentive. Prizes were posted for the best monthly sales. Service Men averaged from \$50.00 to \$75.00 per month extra—that is, above their regular salaries.

## Sales Data

During the month of January, 125 automatic voltage regulators were sold by the Davega Service Men. In February, the number of such sales was increased to 195.

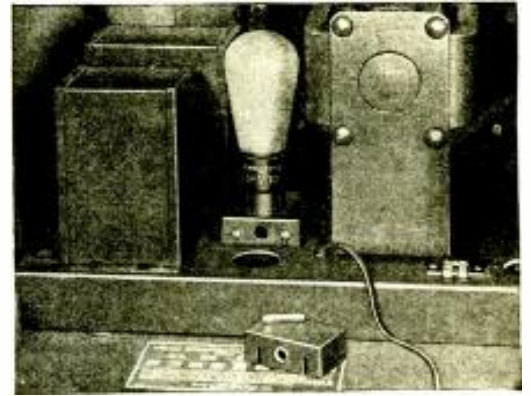

How RCA Victor adds line-voltage controls to its sets. The ease of installation is well illustrated in the sketch below.

During this initial period, the Service Men were gradually becoming aware of the possibilities of the plan. Then, in March, the sales jumped to 1129, in April to 1578, and in May to 1705 and since then, these service-sales have been continuing at a most satisfactory level. The chart in Fig. 1 gives a comprehensive idea of the way in which the Davega Service Men benefited by the new merchandising plan. As a further aid to the Service Man, a pamphlet was given by Davega, to each purchaser of a radio set, calling attention to the troubles arising from line-voltage fluctuations and to the fact that such variations in voltage occur quite often in the metropolitan area. The customer was advised that a Service Man would be pleased to render a voltage analysis and then to install a voltage regulator if necessary. A return post-card was included in the pamphlet.

This promotional work resulted in a further increase in voltage-regulator sales. In addition, the manufacturer of the line-voltage control conducted a direct-mail campaign to give the Service Men timely pointers on selling regulators and also maintained a newspaper publicity and advertising schedule to create public demand for automatic voltage-regulation.

The results obtained by the Davega Service Men have been equalled by many other progressive service organizations in various parts of the country. Any radio concern interested in obtaining additional information regarding the above-described plan may obtain this gratis by writing to the editors of RADIO-CRAFT.

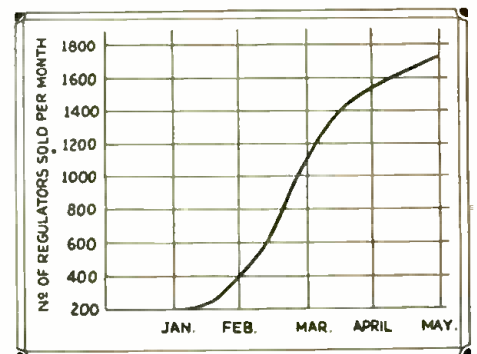

Fig. 1

A chart showing the sales of voltage controls for the months of January, February, March, April and May.



# Operating Notes

## The Analysis of Radio Receiver Symptoms

### SERVICING THE REMLER "14"

By Glenn E. Deamer

**Q**UITE a few of the first Rember "14's," which have given very satisfactory service for some time, are now beginning to require a little attention.

The accompanying illustrations will give the Service Man the data on the terminal board of the power transformer, as well as voltage readings, color code and tube positions of the entire receiver.

Figure 1 is a top view of the chassis; A, are the R.F. transformer shields; B, the aligning condensers; C, the neutralizing condensers; PT, the power transformer; and D, the shield over the tuning condensers.

Then the posts, two antenna and one ground, will be noted at the rear of the chassis.

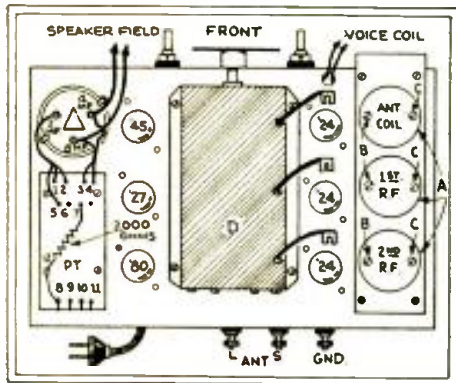

Fig. 1

Top view showing parts layout of the Remler "14". The P.T. connections have also been indicated.

Figure 2 is a complete wiring diagram of this popular receiver. The color code and the wiring positions of the terminals of the power transformer, as marked in Fig. 1, are as follows:

- (1), Red, to A.C. switch and condenser block, .1-mf. condenser;
- (2), Black, to terminal of 8-mf. electrolytic condenser nearest transformer; also red lead to '80 filament;
- (3), Red, to the other side of the '80 filament;
- (4), Other side of A.C. line;
- (5), Yellow, to one plate of the rectifier;
- (6), Center tap of the '45's filament winding, with 2000-ohm resistor to 12 on terminal board, and a jumper connecting 12 to terminal 8, on the under side of the board;
- (7), Yellow, to other rectifier plate;
- (8) and (9), to filament winding of the '24's and '27;
- (10) and (11), to filament winding of the '45;
- (12), terminal used for anchoring the other end of the biasing resistor, bridged under the terminal board of the transformer to (8).

The color code, throughout the set, is as follows: rectifier filament, plate of power tube and speaker field, plate of R.F., and cathode A.F., red; filament '45, cathode '27,

plates '24's, blue; filament of first A.F. tube, detector cathode, and speaker voice coil, black; screen-grid, the plate of first A.F., and the plate of the rectifier, yellow.

Average operating voltages (at a line potential of 115 volts) for the "14" are as follows: Filament potentials: V1, V2, V3, V4, 2.3 volts; V5, 2.4 volts; V6, 4.9 volts. Control-grid potentials: V1, V2, 6 volts; V3, 6.5 volts; V4, 7 volts; V5, 47 volts. Plate potentials: V1, V2, 167 volts; V3, 95 volts; V4, 110 volts; V5, 235 volts; V6, 400 volts. Screen-grid voltages: V1, V2, V3, 105 volts. (Note the extremely high value of S-G. voltage on V3; this figure is given also in the factory manual.)

### UNUSUAL INTERFERENCE SOURCES

By William Murrills

**I**N the November issue of RADIO-CRAFT there was published an interesting case of interference due to leaky power lines which caused noisy reception in nearby aeriads. We continue with the discussion this month.

Another case of copper coupling was discovered when radio reception in a certain hotel was interfered with by a continual crackling sound. Checking up on the power line to the transformer showed an artificial ground connection at a pole behind a theater more than two blocks away. A wire on the pole came too close to a grounded lead sheath, thus causing a grounded connection. By inserting a sheet of paper between the wire and the lead sheath, the interference was completely stopped.

Analysis of another case showed that a defective transformer on a neon advertising sign was setting up a high-frequency current

in the guy wires of the sign, these wires in turn carrying the current to the roof of the building. From there the interference was radiated directly to the antenna of a neighboring radio set. The owner of the sign volunteered to turn the sign off for one month to determine how much difference it would make in the reception; however, he hardly cared to buy a new transformer just to improve radio reception for someone else, as long as the sign itself worked satisfactorily otherwise.

The power company or any other company can do practically nothing to eliminate interference without the hearty support and cooperation of everyone concerned. This is especially true of interference caused by automatic stokers, oil burners, and the like, which can be eliminated by the proper use of filters, providing the owners will cooperate with the company tracing the interference.

### SERVICING A RADIOLA

By John D. Hayden, Jr.

**A** MAN came to my shop one day and asked me if I thought I could fix his Radiola "46." I said that I might, so he told me to go ahead. When I arrived, his wife told me that if I thought that I couldn't fix it to say so, as she had already paid \$10.80 for repairs and it did not work any better. The trouble was very low volume everywhere except at the extreme lower end of the dial. All the other Service Men had replaced a tube and the choke coil and said that the low volume was due to change of location, as the family had moved recently.

(Continued on page 436)

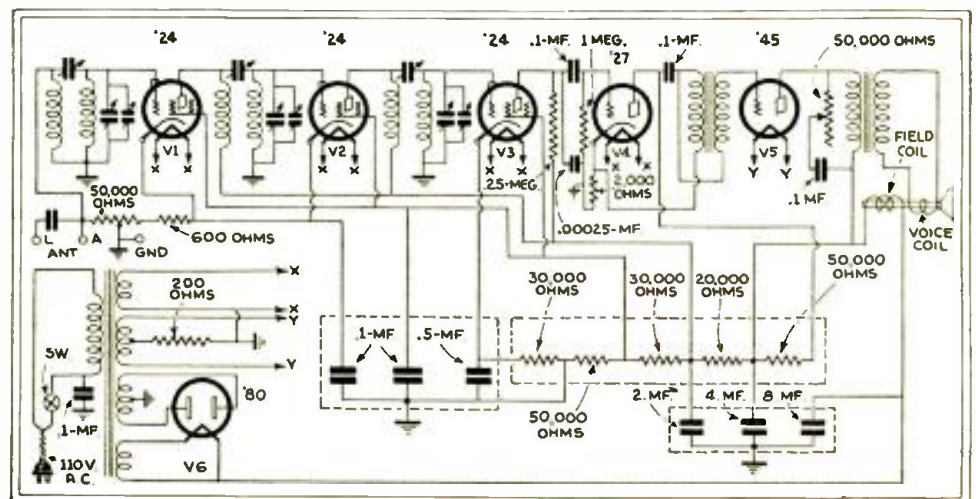

Fig. 2

The complete circuit diagram of the Remler "14". All resistor and fixed condenser values have been indicated on the diagram. The resistors and condensers that are enclosed by dotted lines are built as a single unit.

# The Favorite Testing Equipment of Service Men

## And Practical Methods of Facilitating Their Work

### A SET ANALYZER FOR THE BEGINNER

By Nathan H. Silverman

ORIGINALLY designed for a beginner, who was not to be trusted with the delicate Weston test equipment used in our shop, the little test outfit, shown pictorially in Fig. A and by diagram in Fig. 1, proved to be of such great value that we used it on many jobs, where its special features made it superior to even the most expensive units available.

The most valuable feature is the use of a simple jack, which allows the user to plug in on the detector (or other circuits) of any receiver under test.

Note the following, taken from the remarkable booklet *RADIO SET ANALYZERS* by L. Van der Mel:

"A check of the tube voltages and currents may show that they are perfectly normal and yet the set refuses to function." (Page 4, last paragraph.)

While such cases are not common, the Service Man does come across them occasionally. The use of the phone jack readily locates the possible source of trouble.

#### Features of the Tester

Take a case recently solved by means of this simple method. A type 950 Stewart-Warner was "dead." Tubes, and all voltage and current readings, were O.K., as were the aerial and ground—but the reproducer was silent.

Plugging the test plug into the detector socket of the receiver, and a pair of phones into the jack of the test outfit, we heard music!

The first A.F. gave louder music—and the volume on the last A.F. was deafening.

The trouble? The voice coil of the speaker was shorted. Our continuity test of the speaker showed a full reading. As the voice coil has such a small resistance (about 15 ohms) we did not suspect it.

Another speaker was tried and worked perfectly. Then we took apart the first speaker and found the shorted voice coil.

Another feature is the "HI-LO" switch. Instead of using several buttons for each test, the HI-LO switch makes it possible to get along with only one button.

For example, if HI-LO switch is set on "HI," and plate-voltage button "P" is pressed, we read plate voltage on our 600-volt range. If the lower (300-volt) range is wanted, we merely turn the HI-LO switch to the "LO" position. The same procedure is followed with other tests.

The tube-tester circuit differs from those most generally used. Readers of *RADIO-CRAFT* remember the so-called Campbell tube-tester which created so much comment some time ago.

#### Description of Tester

While this circuit, originally brought out by E. T. Cunningham, Inc., may be as accurate as the one used in our shop, it has several features that did not appeal to us. For instance, if a tube with a grid-to-plate short was put into the tester, the meter

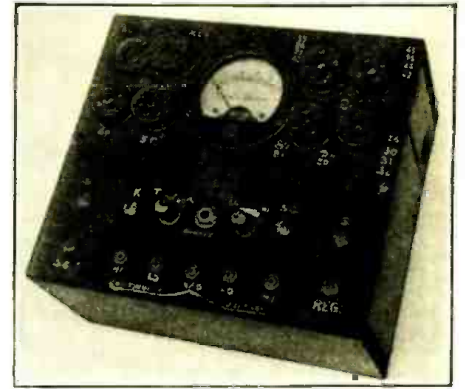

Fig. A

Mr. Silverman's set analyzer.

would be burnt out (found to our sorrow).

You will note in Fig. 1 that we need a 10-volt drop, which is furnished by means of a resistor (about 290 ohms) or else by means of an extra 10-volt winding, placed on the transformer. (Reversed connections will reduce the effective voltage.)

Our transformer was taken from an old Freshman "B" eliminator. We calculated the number of turns needed for the filament windings. The 10-volt winding needed 83 turns ( $8.3 \times 10 = 83$ ). Other transformers will doubtless use a different number of "turns per volt."

No dimensions are given for the carrying case, since various readers will have their own ideas on how much "junk" they want to "drag" around to the job. We carry about 16 tubes, as well as the tester, cables, pliers, screw drivers and other small tools. A pair of headphones is kept in the service car.

#### The Ohmmeter

The ohmmeter has two ranges: with the switch set at "A" (analyzer), we have the high (200 ohms per volt) ohmmeter range; when the switch is set to "T" (tube tester), the shunt is across the meter, and our range is one-third as high—66 2/3 ohms per volt.

A simple ohmmeter chart is located in the cover of our carrying case.

Just for good measure, let us take another example. Suppose our meter read only 0.5-volt, with the resistor.

While plate current is an important test, it was omitted because we wanted to simplify the construction and operation of our tester. With normal tubes, we can assume that normal plate, grid, filament, and S.G. voltages will result in normal plate current.

At any rate, where accurate readings are important, we take the set to the shop where we have the equipment needed for best results.

As a rule, power-pack or other serious trouble is indicated by either a too high, or—in most cases—by a too low, even zero, reading of plate, screen-grid, or grid voltages.

The self-contained ohmmeter helps to locate shorted condensers, as well as open resistors, transformer windings, etc.

The 225-ohm resistor R5 controls the readings obtained on the meter when testing tubes. For best results, use a variable re-

(Continued on page 433)

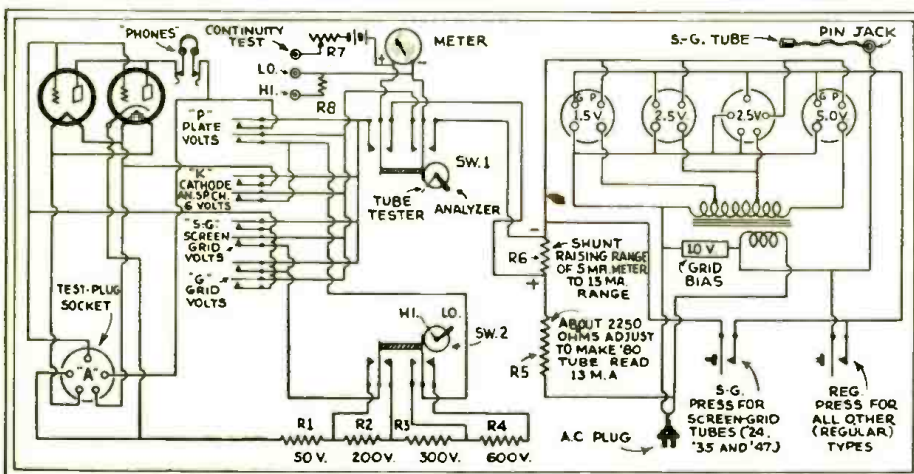

Fig. 1

Schematic circuit of Mr. Silverman's set analyzer. Past issues of *RADIO-CRAFT* contain numerous other articles on this subject which may be consulted for reference.



# The Service Man's Forum

*Where His Findings May Benefit Other Radio Technicians*

## JESSE JAMES HAD A HORSE

Editor, RADIO-CRAFT:

I am writing you this letter for the interest of the Radio Service Business.

Recently, not having much work of my own to do, I answered an advertisement for *Radio Service Men with Cars Wanted*. When I was interviewed, I was told I would be given names and addresses of customers of Landay and Walthal stores, which are now out of business, notifying them that we have taken over the service of said stores.

Then when any customers called for service I was to go and take out the radio chassis regardless of whether the radio only had a bad tube. The idea was to take the chassis out, make necessary *tube* replacement, or repair what was wrong with the radio.

Making a flat rate of \$20.00, regardless of what the trouble was, the customer was the victim.

I then asked my interviewer if the party was not in a position to pay this price what was to be done.

He said either they could borrow money to pay or we would keep the chassis.

Of course, I did not like this way of doing business so declined for the good of the radio service business. When I service a radio, I charge a fair rate for service and parts.

The name of the advertiser mentioned was called Radio Service, 222 Market St., Newark, N. J.

You can do what you see fit for this kind of a "Racket" which may be going on now if he procured men to do that kind of work.

The idea was a 50/50 proposition.

JAMES R. QUINN,

150 So. 13th Street, Newark, N. J.

## PAPA SPANK!

Editor, RADIO-CRAFT:

I wish to register a kick of about two thousand jolts to the article written by a Mr. Rabe of Fremont, Nebraska in July RADIO-CRAFT. With all due respects to Mr. Rabe in his observations in your columns, his remarks in reference to the "correspondence beginners" entitles him to a traumatic deviation of the nasal system.

Apparently, from the moment of birth, he was endowed with full knowledge of radio in all its branches and for that reason looks with withering scorn upon any one that would try to learn its application and then, with his own voice, he cries from the rooftops that he is a *first-class Service Man* and does not put out any information; Ho! Ho! and a couple of Hums! What in the world will the research and experimental laboratories and *second-class Service Men* do now?

If Mr. Rabe wasn't badly decomposed from the neck up, he would know that the correspondence school beginners of the past

## \$10.00 FOR PRIZE SERVICE WRINKLE

**B**EGINNING with the February issue of RADIO-CRAFT, we will pay \$10.00 every month for the best Radio Service Wrinkle received.

Previous experience has indicated that many Service Men, during their daily work, have run across some very excellent Wrinkles, which would be of great interest to their fellow Service Men. Usually, because of the natural modesty characteristic of some Service Men, few people ever hear of their work.

As an incentive towards obtaining valuable information of this type, RADIO-CRAFT will pay \$10.00 to the Service Man submitting the best all-around Radio Service Wrinkle. All others that are published will be paid for at regular space rates. All checks are mailed upon publication.

The judges are the editors of RADIO-CRAFT, and their decisions are final. No unused manuscripts can be returned.

Follow these simple rules: Write, or preferably type, on one side of the sheet, giving a clear description of the best Radio Service Wrinkle you know of. Simple sketches in free-hand are satisfactory, as long as they explain the idea. You can send in as many Wrinkles as you please. Everyone is eligible for the prize except employees of RADIO-CRAFT and their families.

This contest closes on the 15th of every month, by which time all the Wrinkles must be received for the next month.

Send all contributions to Editor, Service Wrinkles, c/o RADIO-CRAFT, 98 Park Place, New York City.

are the radio engineers of the present and the beginners of the present will be the radio engineers of the future. While it may not be absolutely necessary to take a course of training in order to service radios, there are thousands of Service Men who will say that it is the best time and money they ever spent.

Since Mr. Rabe's observation is so keen, it is a wonder to me that he has not observed that the once correspondence-school beginners are to be found in radio factories, radio broadcast stations, ships, government stations, etc., to say nothing of a large number of other important positions in the radio industry. As for Service Men being unwilling to give information, Mr. Rabe need go no further than "Leaves from Service Men's Note Books" in the very pages of RADIO-CRAFT where it stands out in bold print for the whole cock-eyed world to see.

It is my contention that if Mr. Rabe is not careful, he will see the time when some of these correspondence school beginners will plot curves and frequency measurements that will make him dizzy, so to speak. I would suggest to Mr. Rabe that in the future he "lay off" the correspondence school beginner for there are 14,000 others in this family and they might not take it as lightly as I have done.

OSCAR PRESCOTT,  
Vinton, Iowa.

## THANK YOU

Editor, RADIO-CRAFT:

What's the matter with Faulkner? Does he expect that every line of every page in

a magazine will be useful or necessary to every reader? Does this apply to any magazine—fiction, professional, or technical—that he can name?

In RADIO-CRAFT, as in other periodicals, I find stuff that I "knew before," parts that I do not need, and suggestions whose wisdom and value I doubt until I have tried them. What of it? Take the September issue for an example: the article "Pentodes and Their Use" is just now worth to me the price of the whole issue and more. So it goes, no doubt, with the average Service Man to whose needs the magazine is devoted.

There may be a better magazine for the Service Man somewhere but I haven't found it yet. I find the Operating Notes, Service Men's Department, Leaves from Note Books, Craftsman's Page, and Information Bureau packed full of useful information and help.

Whether an open antenna lead will cause oscillation in the RCA "44," I do not know, but it will in some sets and in some cases and for this reason the information was useful to some Service Man somewhere.

Mr. Faulkner is right in objecting to the remark about "other Service Men." We are all leeked occasionally—and sometimes by the simpler things.

RADIO-CRAFT may be improved as a service magazine from my own point of view, but would others agree that my changes were improvements? Here's to a long life and a fat circulation to it in its present form.

DAVID HOYLE,  
Box 94, Coleman Alberta, Canada.

## GENERAL MOTORS 7-TUBE SUPERHETERODYNE CHASSES S1A 60 CYCLES AND S1B 25 CYCLES

### Receiver Models Little General 250, Standish 216, Tudor 217 and Continental 219

These receivers are products of General Motors Radio Corp., Dayton, Ohio. Except for the modifications for 25- or 60-cycle supply, the chasses are the same. The circuit and the mechanical arrangement are that of a 7-tube superheterodyne midget set, incorporating a pentode output tube.

The following characteristics are given for service reference.

Pentode bias resistor PB, green, 52,000 ohms; red, 2/10-meg. The voltage divider VD, red, 25,000 ohms; brown, 15,000 ohms. In the following references, the body color is first, end color second, and spot color third. Resistor R1, yellow-green-red 4,500 ohms; R2, red-green-orange 25,000 ohms; R3, yellow-black-orange 40,000 ohms; R4, brown-black-yellow 100,000 ohms; R5, green-black-yellow 1/2-meg.; R6, (in metal cover) 400 ohms. All these units are of 1/2-watt rating.

Condenser C1, 10 mmf.; C2, 500 mmf.; C3, .002-mf.; C4, .01-mf.; C5, 0.1-0.1-mf.; C6, 0.1-mf.; C7A, C7B (green leads), 0.25-mf.; C7C (brown), 0.1-mf.; C7D (terminal), 0.25-mf.; C7E (red), .006-mf.; C7F (green), 0.25-mf.; C7G (blue), .03-mf.; C7H (white-blue), .03-mf.; C8 (electrolytic), 4.4 mf.; C9 (electrolytic), 8 mf.; condensers C7A to C7H, inclusive, are included in the bypass condenser pack.

Operating voltages are as follows: Filament potential, V1, V3, V4, 2.1 volts; V2, V5, V6, 2.15 volts; V7, 4.5 volts. Plate potential, V1, V3, V4, 225 volts; V2, 75 volts; V5, 125 volts; V6, 210 volts; V7, 300 volts. Control-grid potential, V1, 2 volts; V2, 0.0 volts; V3, V4, 3.3 volts; V5, 15 volts; V6, 1.0 volt. Screen-grid potential, V1, 85 volts; V3, 79 volts; V4, 75 volts; V6, 200 volts. Cathode potential, V1, 7 volts; V2, 0.0 volts; V3, V4, 5 volts; V5, 15 volts. Plate current, V1, V5, 1.0 ma.; V3, 14 ma.; V4, 13 ma.; V6, 3.5 ma.; V7, 25 ma. (per plate). Line potential 110 volts and volume control on full.

On models 216, 217 and 219 a special antenna is installed in the cabinet and an antenna and ground terminal strip with three clips is

located on the bottom of the speaker baffle board. If an outside antenna and ground are used, connect the antenna lead-in wire to the clip marked "A" and the ground wire to the clip marked "G." The jumper wire provided should connect clips marked "G" and "X." If the local-reception antenna in the cabinet is used, connect the special antenna lead to the clip marked "A." The jumper should connect clips marked "G" and "X."

If the power line is to be used as an antenna, simply connect clips "A" and "X" by means of the jumper. If possible, connect a ground wire to the clip marked "G." The outside antenna gives the best results in all cases. However, there may be cases where the installation of such an antenna is impractical. The special antenna will give best results in cases where the electrical wiring is inclosed in metal conduit; the power line will give better results in homes where the power lines are not inclosed in metal conduit.

If the line potential exceeds 120 volts, a standard limiting resistor must be connected in the line. Potentials above this value may cause the electrolytic condensers to break down.

The pilot light, a Mazda No. 41, 2 1/2 volts, is easily replaced by removing the entire socket assembly, straight up and backward.

If the pointers on the window of the eschecheon plate do not correctly indicate the frequencies of the stations being received, the dial may be rotated as desired by loosening the two set screws which hold the dial and hub assembly to the tuning condenser shaft. To do this, it is necessary to remove the chassis from the cabinet.

With the chassis removed from the cabinet, measure the distance from the chassis shelf to the indicating points on the eschecheon plates (inside the cabinet). Loosen the selector set screws, and tune in a station of known frequency. Hold the condenser rotor stationary and turn the selector dial on the shaft until the distance from the bottom of the chassis (with the base plate in place) to the mark which in-

dicates the frequency of that station is 1/16-in. less than the distance measured to the indicating points on the eschecheon plate. (This is to allow for the angle at which the dial ordinarily is viewed.)

The first-detector V1 is a screen-grid tube; the second-detector V5 is a '27. Variable-mu tubes V3, V4 are used only in the I.F. circuits.

Fixed tone correction in the pentode output circuit is obtained by means of condenser C7E; adjustable tone control, by bypassing still more of the high frequency output, is obtained by means of fixed condenser C7G and the variable resistor in series with it.

Ten resonant circuits, finely adjustable by trimmers, result in exceptional selectivity and sensitivity in this chassis design.

The chassis may be removed by taking out six wood screws (diagonally through the baffle board and into the sides of the cabinet). The entire speaker and chassis assembly can then be removed by lifting the baffle board.

In this model receiver there are three tuning condensers ganged for single dial operation. The trimmers in shunt to each of these condensers are not indicated in the schematic circuit. The oscillator frequency is transferred to the grid circuit of the first-detector V1 by means of a small pickup coil which constitutes part of the oscillator inductance L3. This alternating voltage is applied to the detector grid circuit as a rise and fall of the cathode potential,—since this coil, through condenser C5, is in shunt to cathode bias resistor R1. Obviously, if insulating condenser C5 should short, bias resistor R1 would be shorted out of the circuit.

The intermediate frequency to which this portion of the circuit is to be adjusted is 175 kc. In some receivers using I.F. transformers of the tuned-plate tuned-grid type, such units as IF1, IF2, and IF3, it is customary to "flat top" the tuning; in this set, however, the I.F. circuits are resonated at the "peak."

The volume control is common to two circuits, the antenna, and the cathode circuits of I.F. amplifiers V3 and V4.

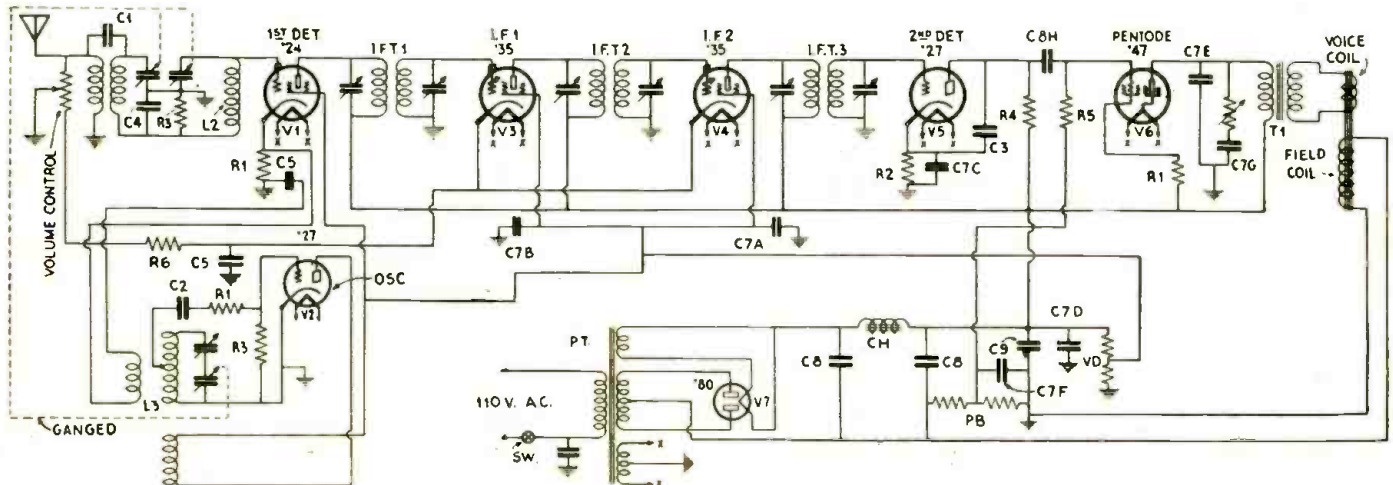

Schematic circuit of the General Motors receiver most commonly referred to as the Little General; the same chassis, however, is used in a number of other models, as indicated at the head of this Data Sheet. Decreasing the effective resistance across the primary of the input R.F. transformer by moving the contact arm toward the antenna, results in an increase of the resistance in the cathode circuits of V3 and V4, thus increasing the control-grid bias of these tubes.



DELCO 32-VOLT RADIO RECEIVER CHASSES

Models RB-3 Console, RC-3 Jr. Console and RA-3 Compact

These three cabinet model receivers, designed for farm districts powered by 32-volt supply systems, are manufactured by the Delco Appliance Corp., Rochester, N. Y., and employ the same chassis, the schematic circuit of which is shown below. The 32-volt or "farm lighting" power line supplies only the filament potential, as shown; the plate potentials must be obtained from a block of "B" batteries or from a Delco Power Unit.

Before connecting the power unit, turn the power switch to the "off" position. The power switch is incorporated in the volume control and is turned off by turning the left-hand knob to the left or in a counter-clockwise direction as far as it will go. Connect the power unit to the chassis by means of the 3-lead cable according to the following color code: red, "Plus 135 V." connection on the Delco power unit; maroon, "Plus 67.5 V." tap; black, the negative lead. The "A" lead on the receiver chassis is plugged into the 32-volt power line; reversing the position of the plug in some instances may improve reception a little.

As indicated in the diagram, this 32-volt chassis employs four type '36 or 2-volt screen-grid tubes and two type '38 or 2-volt pentodes; these '38's are connected in parallel,—plate-to-plate, grid-to-grid, etc.

In shunt with each of the tuning condensers in the gang is a trimmer. The nuts of these small condensers are accessible for adjustment through four holes in the top of the condenser shield. A bakelite aligning tool must be used, in order to prevent injury to the inductances within their respective shield cans. The frequency at which it is recommended that this chassis be aligned is 1400 kc. Adjust the volume by means of the volume control until the station signals can be heard faintly but clearly.

If the pointers on the dial window do not correctly indicate the frequency of the stations, the dial may be rotated to the correct position. To do this, it will be necessary to remove the chassis from the cabinet.

After the chassis is removed from the cabinet, measure the vertical distance from the bottom of the cabinet to the indicating points on the dial window (inside the cabinet). Tune in a station of known frequency and loosen the two square-head set screws which hold the dial and hub assembly to the tuning condenser shaft. Hold the condenser rotor stationary and turn

the selector dial on the condenser shaft until the frequency shown on the selector dial at that particular station is the same vertical distance from the bottom of the chassis as that previously measured from the bottom of the cabinet to the indicating points on the dial window inside the cabinet.

Lock the selector dial assembly on the shaft by tightening the two square-head screws and reassemble the chassis in the cabinet.

The dial light is rated at 6 volts and has a standard flash-light base. It can be removed or replaced easily by lifting the dial light, socket and bracket assembly up and off the dial light mounting bracket.

A good ground connection is necessary for best operation. Use an approved ground clamp to make a connection to a cold water pipe or a six-foot iron rod driven into moist ground. The antenna may be 100 to 150 feet long.

The knob at the left of the station selector dial window operates the combination volume control and off-on switch. The toggle switch located on the left-hand side of the cabinet is the local-distance switch shown in the schematic circuit as SW.1. The large knob at the right is the tuning control and the central one is the tone selector.

Note that when the local-distance switch is in the up or "distance" position, the receiver is adjusted for maximum sensitivity. However, when the switch is in the down or "local" position battery power is conserved, as described below. In this position the volume on distant stations is very greatly reduced, and satisfactory reception is possible only from local stations. Incidentally, this provides better control of volume on local stations and, as will be observed by reference to the schematic circuit, there is conservation of the battery current.

Tubes for these 32-volt receivers are available from the Delco company, and are somewhat special in their characteristics, although, in lieu of these, the more standard types may be used; they carry the designations D-236 for the screen-grid type, and D-238 for the pentode.

As will be evident by reference to the schematic circuit, the problem of operating on a 32-volt supply necessitates the use of a receiver design entirely different from other types. To meet this situation adequately it has been considered advisable, in the design of the Delco 32-volt radio set, to limit the line current de-

mands to supplying only the filament current required by a number of heater- or cathode-type tubes, the '36's and '38's shown in the schematic circuit. This system of connection eliminates the need for heavy filter chokes in the "A" circuit.

There then remains the matter of supplying "B" and "C" potentials to the circuit. The most satisfactory solution to this problem, it was decided, would be the use of "B" batteries to supply "B" current; and the principle of voltage drop across a resistor in series with the "B" supply to furnish the required "C" potential. Of course, this voltage is subtracted from the total "B" voltage available, and the remainder constitutes the voltage which will be available for use at the plates of the tubes.

The "C" potential for tubes RF1, RF2 and RF3 is the drop across a fixed 250 ohm resistor and that portion of a variable 45,000 ohm resistor which may be in the circuit at the time; variation of this value constitutes the only volume control in this receiver,—except for the change which is effected when switch SW1 is operated, or the tone control is adjusted.

The detector is of the plate-rectification or power type, the high negative bias required for this form of circuit operation being obtained as the drop across a 25,000 ohm resistor in the screen-grid detector cathode lead. Bias for the pentode tubes is obtained from a 750 ohm cathode resistor. The power output circuit is not push-pull but is parallel, as previously stated.

The screen-grids of the pentodes are isolated from the plates, as far as A.C. is concerned, by means of an iron-core choke coil and 1. mf. fixed condenser in the high voltage lead common to both, as shown in the schematic circuit. The output of the pentodes is transformer-coupled to the dynamic reproducer voice coil by means of the usual output-type audio transformer; the field coil of which is connected directly across the 32-volt supply.

To improve the tuning characteristics, small coupling condensers are connected to the high potential ends of the R.F. tuning coils.

A line-filter, consisting of two, 0.1-mf. fixed condensers connected in series and the center-tap grounded, is connected across the 32-volt power line. Its use prevents surges from affecting the operation of the set.

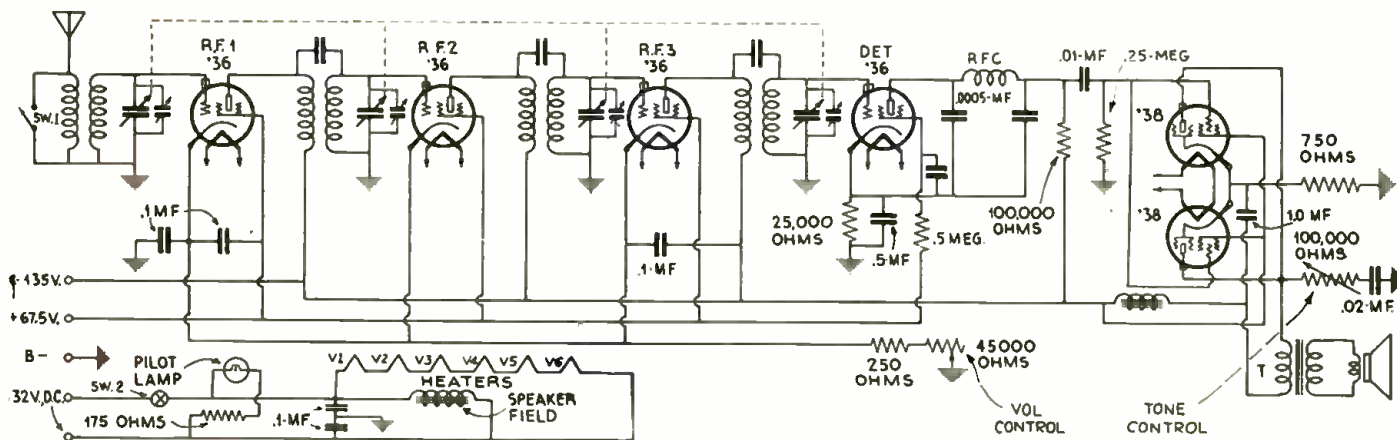

Schematic circuit of the Delco 32-Volt Receivers, Models RB-3 Console, RC-3 Jr. Console, and RA-3 Compact. The detector is resistance-capacity coupled to the power output tubes through a fixed condenser of .01-mf. It is always well to check condensers in this position, for leakage; occasionally, an open circuit may develop, and the usual tests should be applied where such a condition is suspected.

# HOW TO BUILD A Portable Recorder

By GEORGE J. SALIBA, S. B.



Fig. A

*Left, three-stage audio amplifier and indicating and control units; right, pickup, turntable and volume level indicator.*

**T**HE successful commercial application of any new art is always a measure of its merit. It instantly separates the new art from the toy stage and graduates it into the business stage. The period of transition is usually a long hard-fought battle but ultimate success is always achieved if the new art is properly exploited. When radio broadcasting was introduced to the public, it was scoffed at by the hard-headed business man who could not see where the studio could be made to pay enough to justify its existence, but as we all know, broadcasting through proper exploitation has today become our most powerful and effective advertising medium. While recording cannot be compared to radio, it has gone through the same transitory period. Starting in the home as a novel means of entertainment, it has forged ahead until today, in spite of a universal business depression, it is proving a good money-maker.

A branch of instantaneous recording which is now enjoying phenomenal success is the portable end. While this branch has been exploited only in the past few months, it has had such success as to merit the statement that it will be one of the most lucrative branches of recording in the future.



Fig. B

*Interior view of the amplifier cabinet of the portable sound recorder.*

## Uses of the Portable Unit

The uses to which a well-built portable apparatus can be put are many, and it is the purpose of this article to point out the many new applications and to describe also a complete recording unit.

One of the most common uses of the portable recording machine is to take it into the home to record the voices of the different members of the family and to form a voice album similar to the picture album. If the family has young ones, then periodic visits can be made so that the voices of the children at different stages of their growth are preserved. Some might argue that the studio can easily render this service, but it must not be forgotten that the photographer who takes his photographs in the home has always been successful and always will be, so why can't the professional recordist do the same thing? Individuals are much more at ease in their own homes with familiar surroundings than in the studio, and this in itself is a tremendous

*(Continued on page 430)*



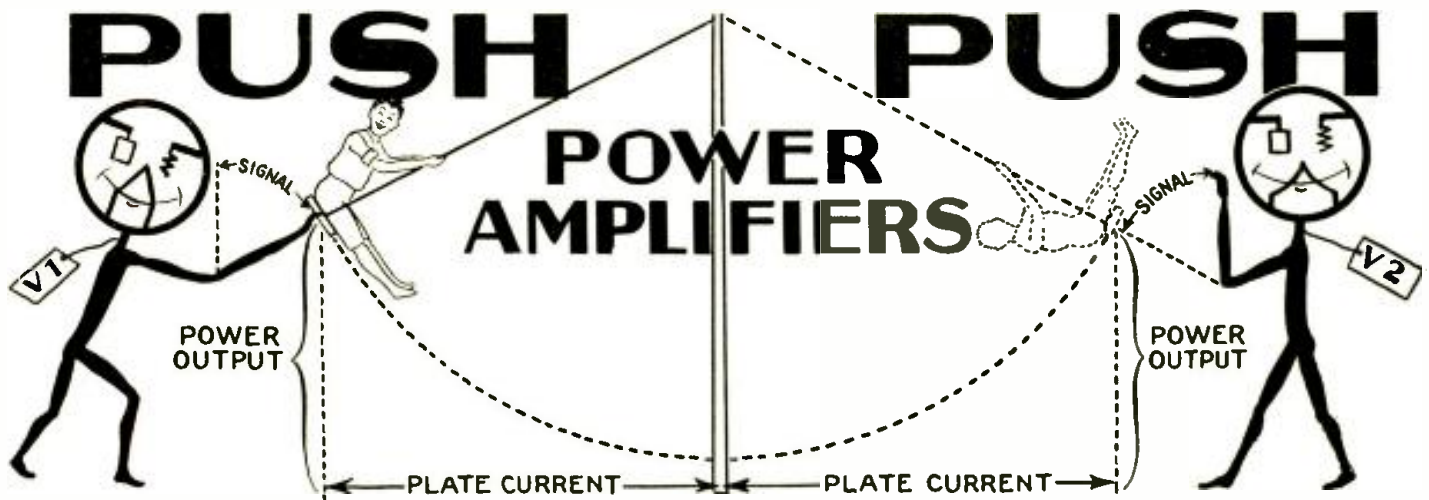

**AMAZING AMPLIFICATION**  
**POWER** output six times greater!  
 These few words portray the startling results which may be obtained by connecting standard tubes in "push-push" and biasing the grid circuit to plate-current cut-off as described by Mr. Nason.  
 Within a few months, many custom-built circuits will include the push-push amplifier.

**T**HERE are two accepted methods for obtaining a large audio frequency power output with low voltages.

The first involves the use of several tubes in parallel. Under these conditions the power output obtained is that of a single tube, multiplied by the number of tubes employed in the parallel arrangement—within certain limits governed by special considerations of a highly technical character.

The second is termed the "push-pull amplifier" method due to the fact that the circuit arrangements are such that both tubes are in action at all times, but with their grid excitation "in phase opposition"; that is, the plate-circuit signal voltages are additive for currents of the same frequency as the input signal, but in phase opposition for even harmonics generated in the individual tube circuits.

This fact results in a power output for two tubes in the push-pull connection of about 2.4 times that obtained with a single tube because of the fact that the tubes may be driven over a portion of the characteristic curve having a marked departure from the linear before the distortion incurred becomes objectionable. Most receivers of high fidelity employ push-pull output circuits.

**Amplifier Classification**

The usual audio frequency amplifiers are termed Class "A". These amplifiers are so biased as to operate over a substantially linear portion of their characteristic curves and in such a manner that the output wave form is substantially that of the input. Fig. 1 shows the grid voltage—plate current curve for a Class "A" amplifier.

It will be noted that the tube is given an initial bias such that the signal varies the

By C. H. W. NASON

grid voltage about a point nearly midway of the linear portion of the characteristic. The interests of high quality demand that the signal be limited in such a manner that the grid is not driven positive during the positive signal peaks and that operation is limited to the linear portion of the curve.

In the case of push-pull amplifier operation, it is permissible that the input signal drive the tube slightly beyond the linear range, as the second-harmonic distortion thus incurred cancels out in the plate circuit of the push-pull stage. In designing push-pull amplifiers, the load impedance is chosen for the minimum third-harmonic distortion inasmuch as the second-harmonic components will cancel out.

Class "B" amplifiers operate in the manner shown in Fig. 2. The operating bias is so chosen that with no input signal the plate current is reduced to zero. The bias required to achieve this end is obtained under certain conditions by dividing the operating plate voltage by the amplification factor of the tube. Due to the fact that the plate current has already been reduced to zero, it is obvious that the tube will be inoperative during those portions of the signal wave driving the grid still further negative. It is also readily seen that the output wave form will represent only the positive half-

cycles of the input signal. This fact is demonstrated in the figure.

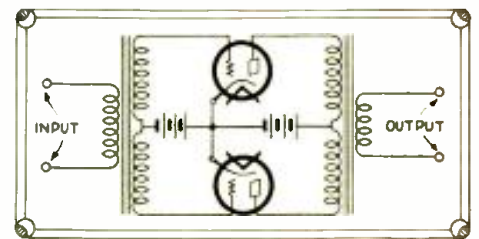

Fig. 3

A "push-push" power amplifier. Divide  $V_p$  by  $\mu$  to obtain the tube's grid bias for plate current cut-off.

**The Push-Push Amplifier**

Some years ago, in a series of articles on the theory of low frequency amplifiers, the writer made note of an amplifier especially designed for operation at low plate voltages but with a relatively high power capability. This was the "Push-Push" arrangement as originally developed by Alexanderson of the General Electric Company.

In a recent issue of the Proceedings of the I.R.E., L. E. Barton gives data on the calculation of the power output obtainable with existing tubes under these conditions of operation. The "push-push" amplifier em-

(Continued on page 437)

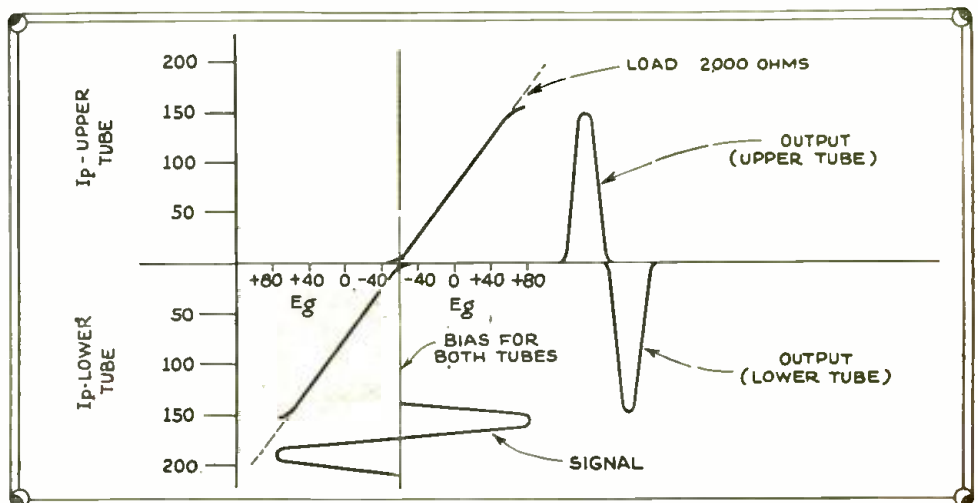

Fig. 4

Alternate operation of two tubes connected for performance as a "Class B" power amplifier is indicated in this graph. The schematic circuit is Fig. 3. Note that operation is around zero grid potential.

# A Superhet Booster Stage

A Description of a Device That Converts a T. R. F. Receiver to a Superhet.

By HENRY C. McCARTY

**S**OMETHING a bit "different" in instrument design, is the device which the writer designed and built out of odds and ends, some time ago. This instrument, a front view of which is shown in Fig. A, is a booster unit operating on the superheterodyne principle; the completed device may be placed alongside (and connected to) the regular broadcast receiver, and serves to heterodyne all incoming broad-

cast signals to the lowest (intermediate) frequency to which the broadest set can be adjusted (the writer uses a Majestic Model 91, which will tune down to 540 kc.). This action will be clearly understood by reference to the schematic circuit, Fig. 1.

In the localities in which the writer has lived, it gave ten kc. separation on local stations,—something that the best of factory-built "supers" would not do at the high-

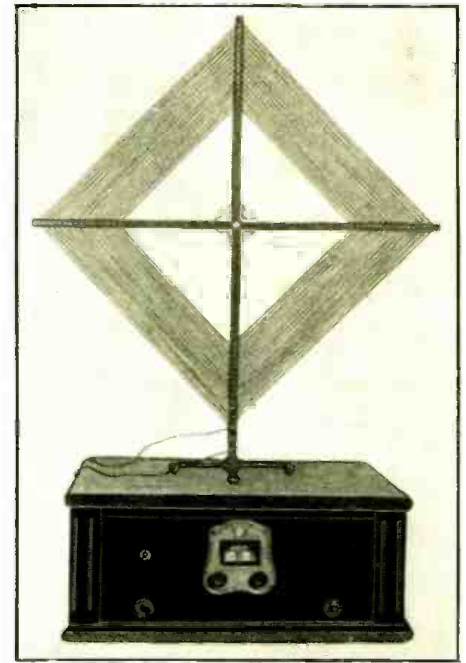

Fig. A

A front view of the McCarty booster.

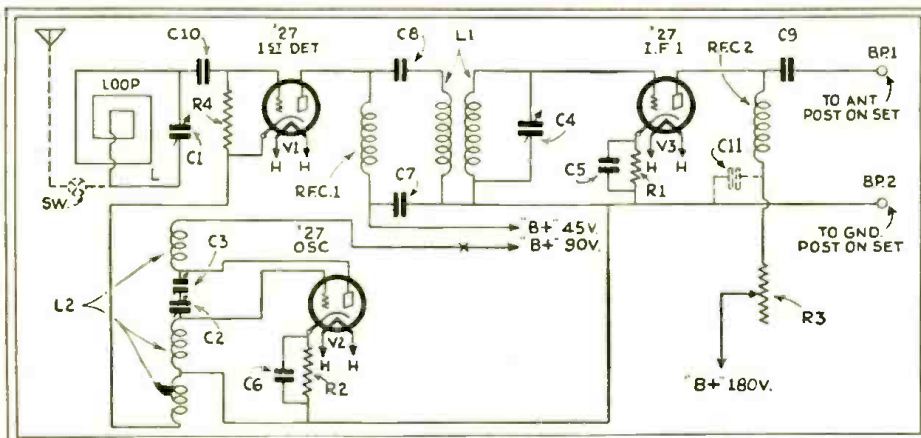

Fig. 1

Circuit diagram of the McCarty booster, which is connected between the antenna and the broadcast receiver. An incoming signal is heterodyned by means of an oscillator to some frequency in the broadcast band, and then amplified by the broadcast receiver.

frequency end of the dial. While living in San Diego, California, verified reception of a 1000-watt station in Syracuse, N. Y., was obtained, while a 1000-watt station on the same channel, about 100 miles away, was going full blast! On the broadcast receiver, the channel was a hopeless heterodyne. The local station (in Pasadena) was perhaps two or three kc. off its 1360 kc. channel, and was later removed from the ether by the Radio Commission, but this incident illustrates the exceptional selectivity of the booster.

### Construction Details

The oscillator coil L2 is wound on a two-inch form, as shown in Fig. 2. The plate and grid coils consist of 24 turns each of No. 28 D.S.C. wire. The pick-up coil is 6 turns of No. 28 D.S.C.

Variable condenser C3 in series with C2 prevents accidentally shorting the 90 volts  
(Continued on page 439)

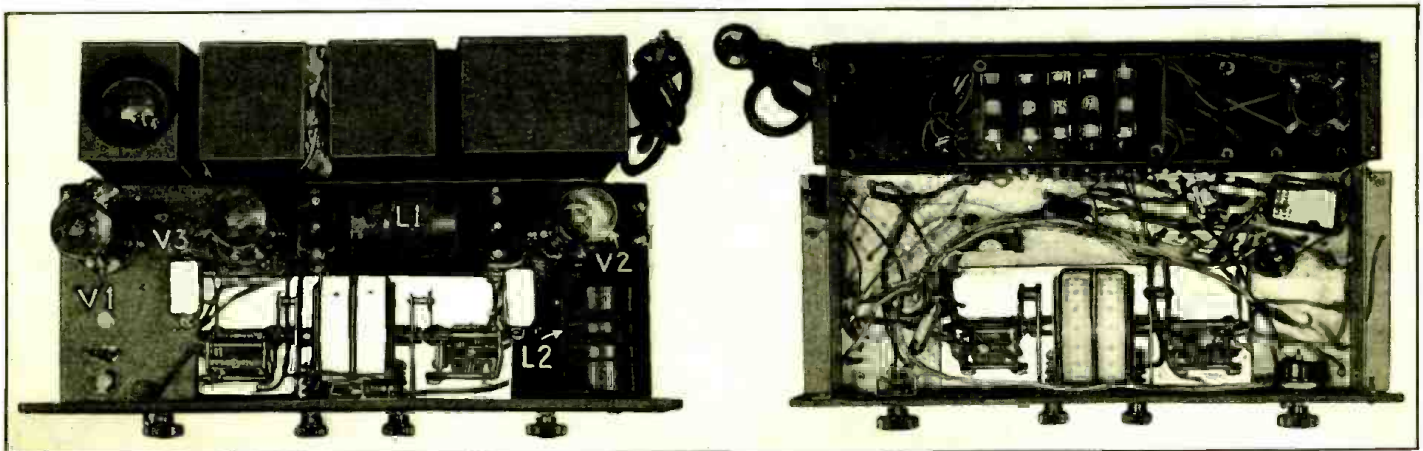

Fig. B

Top view of the receiver. Note the excellent arrangement of the parts and the right-angle positions of L1 and L2.

Fig. C

Under-view of the set. The wiring is clearly shown in this photograph. Observe the double drum tuning dial.



# A Modern All-Wave "SUPER"

## A Description of a Modern Superheterodyne

By

W. H. HOLLISTER\*

**I**N the new Lincoln Model DeLuxe SW-32 All-Wave Receiver, a front view of which is shown in Fig. A, we find the latest "last word" in short-wave radio receiver design.

The pentode tube ordinarily is incorporated as a means of obtaining high power output and, due to its rising characteristic, ordinarily requires some form of high frequency compensation in the audio output circuit; however, the power output of the model SW-32 is so great that no advantage was to be obtained by the use of pentode tubes, and the use of type '45 power tubes in push-pull made it unnecessary to include in the output circuit any form of frequency compensation.

### The Receiver

Perhaps the greatest single factor in the high power output of this chassis is the use of four stages of high-gain screen-grid amplification; these screen-grid tubes are V1, V3, V4, V5, and V6 in the schematic circuit, Fig. 1. Each intermediate frequency transformer is shielded, as indicated by the dotted lines. Within each shield can be the I.F. transformers and the primary tuning



Fig. A  
Front view of the Lincoln All-Wave Superheterodyne.

condenser, one above the other. There are five of these tunable transformers and after they have been adjusted for maximum signal strength from a local station, are to be re-balanced for greatest volume from the weakest station which can be picked up.

The Model SW-32 receiver has been designed for 10 kc. selectivity when all of the circuits are correctly aligned.

The simplicity of control which has been achieved in this receiver design is best appreciated by reference to Fig. A. The cen-

tral control on the small front panel, of course, is the tuning knob which operates the two-gang bathtub-type variable condenser. The knob to the right of the tuning control operates a combination volume control resistor and off-on power switch; the one at the immediate left varies a trimmer condenser. At the extreme left is another and ornamental knob which controls the hand-selector switch; and at the extreme right, a low-high switch which prevents over-

(Continued on page 441)

President, Lincoln Radio Corp.

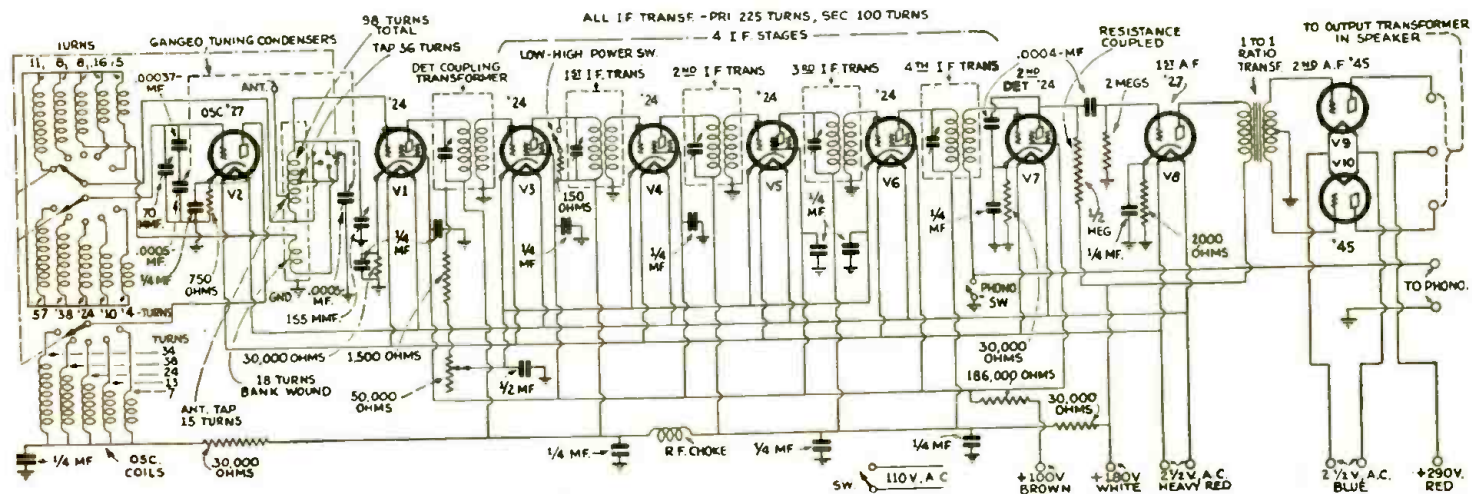

Fig. 1

Circuit diagram of the Lincoln DeLuxe SW 32 All-Wave Receiver. This receiver utilizes a tapped coil arrangement to facilitate wave length changes, obviating the necessity of using plug-in coils. All values are marked on the diagram.



Fig. C

# SERVICE-SELLING

*All-Wave*

# SUPERS

(PART II)

By McMURDO SILVER\*

**I**N the December, 1931 issue of RADIO-CRAFT was discussed the new problem which faces the modern Service Man,—that of servicing "all-wave" receivers, particularly those which employ the superheterodyne circuit. At the same time, the extremely important matter of keeping the receiver sold was analyzed and shown to be the Service Man's responsibility. The schematic circuit of a typical set was illustrated as Fig. 1; it is pictured in Fig. C. We now continue the discussion.

In the first place, a good short-wave receiver can not be tuned by the hit or miss method as may be done with a broadcast band set, for between 10 and 200 meters lie about twenty-eight times the number of channels that lie in the broadcast band and only a few of them are occupied by short-wave stations. The first thing, therefore, that the Service Man needs is a log with time schedule of both the domestic and foreign short-wave stations shown in Fig. 2, and a tuning chart for the set itself, indicated in Fig. 3. With these in hand, he approaches the receiver, makes certain it is operating properly on the broadcast band, throws the selector switch into the short-wave position, and attempts to tune in a signal. In order to do this, he first selects a station which he knows is operating, looks on the chart accompanying the receiver to find out at what position on the short-wave dial this station should come in, sets the broadcast band tuning dial somewhere on a clear channel between 600 and 700 kc., turns his volume control up, and "fishes" about the setting of the short-wave dial at which the station should be received. At first, he probably "fishes" hurriedly, but possibly hearing nothing, he sits down to a very careful tuning throughout a range of five degrees above and below the point on the short-wave dial at which the station is to be heard; if it is operating, the chances are that nine times out of ten he will hear it, or failing to hear it, he will hunt for another station on some other wavelength. As soon as he has tuned in a station, he turns the volume down and adjusts the short-wave trimmer between the two tuning dials until the signal is loudest. This done, he brings out his ever-trusty screw driver and, going behind the receiver panel, finds a small compression type mica condenser directly above the trimmer, Ca in the diagram. He then carefully adjusts this condenser, turning it in as far as possible without allowing its adjustment to cause any appreciable change in the setting of the trimmer on the front panel. In other words, it is his aim to increase the capacity of Ca as much as possible without allowing it to react upon the setting of the short-wave trimmer Ce, on the front panel. This done, the adjustment of the receiver is completed, and it is now only necessary to pay very careful attention to the tuning chart accompanying the receiver and to his log of short-wave stations, to make sure that the ones he hunts for are operating at that time. Some of them, of course, will be received with rather poor tone quality and he will have to explain to the

customer that this is to be expected at certain times on some stations, but in general he will have no difficulty in tuning in a number of very satisfactory short-wave programs, in all probability including one or two foreign ones.

After doing this, the Service Man then takes the customer very carefully through the entire routine of tuning the short-wave portion of the set, making the customer, himself, perform each operation in order that he may thoroughly familiarize himself with the method of tuning the short-wave end of the receiver, and with the facts that it requires careful attention, a log of stations, a tuning chart, and a knowledge of whether or not the station sought is actually on the air at the time (for there are not so many short-wave stations on the air at all times of the day and night that they can be logged with the same ease as can the regular broadcast stations).

Having done all this, the Service Man points out that on some stations that are somewhat difficult to tune in directly with the short-wave tuning dial, a helpful vernier effect can be obtained by using the main, or broadcast band tuning dial as a short-wave vernier, this tending to shift the short-wave I.F. frequency in much smaller steps per dial division than the short-wave dial directly shifts the tuning frequency of the short-wave oscillator. Whether or not this vernier action of the broadcast tuning dial can be used is dependent of course upon whether or not there are several clear broadcast channels near the setting that is used for the broadcast band dials in short-wave reception.

Because of the extreme sensitivity of the receiver, local broadcast stations may be picked up without any antenna whatsoever and under favorable winter conditions, possibly even one or two distant ones, so that it is possible that there may not be a sufficient range of clear channels to allow the use of the broadcast band dial as a short-wave vernier. This, however, is improbable, for the receiver is very thoroughly shielded and only rarely will it be possible to pick up more than one or two broadcast stations without an antenna, although, because of its sensitivity, three or four feet of wire as an antenna will generally give extremely satisfactory results.

Incidentally, it is important for the short-wave portion of the receiver to be logged in order that the setting of the broadcast band dial always be the same whenever the receiver is being operated.

As the well-equipped Service Man will have provided himself with manufacturers' service bulletins covering receivers which he is called upon to service, there is little point in reviewing in general the procedure which will be necessary for each particular set. Nevertheless, to lay stress upon certain more important general aspects which are not often sufficiently forcibly stressed in manufacturers' service bulletins themselves should not be amiss.

(Continued on page 420)

\* President, Silver-Marshall, Inc.



# RADIO-CRAFT KINKS

*Practical hints from experimenters' private laboratories.*

## TUNING IN SHORT WAVES

By John C. Heberger

If one has a modern broadcast receiver equipped with a power amplifier tube and a short-wave set with at least one stage of audio amplification, foreign short-wave broadcast stations can be tuned in on the loud-speaker of the broadcast receiver if the two receivers are connected together according to the simple diagram shown in Fig. 1.

The writer tunes in daily, by means of this combination, the afternoon programs from G5SW at Chelmsford, England, with volume and quality equal to a local station. Three stages of amplification are none too many because the level of background noise is usually very low on the short waves. Howling caused by mechanical feed-back from the speaker may be avoided by using a longer speaker cord or, if necessary, placing the speaker in another room.

Referring to Fig. 1, the lamp cord "A" joining the two receivers can be of any length, and if the sets are located in different rooms the phones "B," which are left connected all the time, can be used to find the station before putting it on the speaker.

The switch SW is placed inside the cabinet of the broadcast receiver in any convenient position. One side of the switch connects the output of the short-wave set to the input of the audio amplifier of the broadcast set; the other side is used for normal operation of the broadcast receiver. Care should be taken in connecting the leads to the switch so that the connections to the transformer are not reversed when reconnected to the detector of the broadcast receiver through the switch.

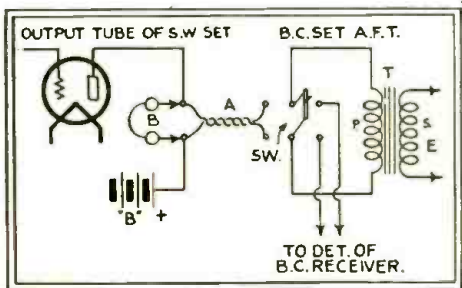

Fig. 1

Short or broadcast waves on the L. S. by switching the S. W. set to the A.F. of the B. C. set.

## A HINT TO SHORT-WAVE FANS

By Wayne Starch

MANY short-wave fans, like myself, may have short-wave sets which tune up to about 150 meters. Probably, at times, they wished that they could tune a little higher in order that they might receive broadcasts when the short-wave stations

are not on the air. In my case, it happened that I wanted a friend of mine to hear the dynamic speaker that I was using, but was unable to do so in view of the lack of short-wave stations at the time. I decided then and there to fix up my receiver so that I would be able to tune in a few of the higher wave broadcast stations.

Instead of winding a new R.F. coil, I obtained an old one from my junk box (most radio experimenters have junk boxes) and used its secondary as the secondary of a new plug-in coil, and the primary as the tickler. This idea is shown in Fig. 2. I found it necessary to reverse the tickler connections on the new coil in order that regeneration might be secured. The antenna was connected to the P terminal of the tickler rather than the antenna coil as shown.

The type of plug-in system to use depends on the type that the short-wave receiver uses, and obviously should be made so as to fit.

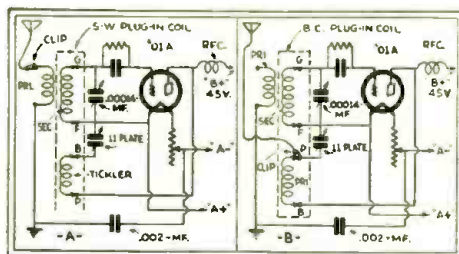

Fig. 2

At A, a standard short-wave connection. At B, circuit changes for longer wave reception.

With the size tuning condensers as shown and using a standard R.F. coil, the range of the set was extended up to 345 meters.

## A SOLDERING IRON HOLDER

By Louis Rick

THOSE of us who have used soldering irons for a few hours at a time know that it requires frequent manipulation of the line plug in order to keep the iron at a constant working temperature. The simple arrangement depicted in Fig. 3 has been in use by myself for some time, and I have found it very satisfactory.

The idea is merely to connect a 60-watt lamp in series with the soldering iron. When the iron is removed from its holder, the contact K closes, short-circuiting the lamp; the full line voltage is then applied to the iron. When not in use the iron is placed on its holder, which opens the contact and connects the lamp in series with the iron; reducing the voltage applied to the iron. With the usual amount of use, the iron is thus kept at a constant temperature.

At A is shown a schematic diagram of the circuit. The entire arrangement may be housed in a box illustrated in B, Fig. 3, and then mounted in any convenient location.

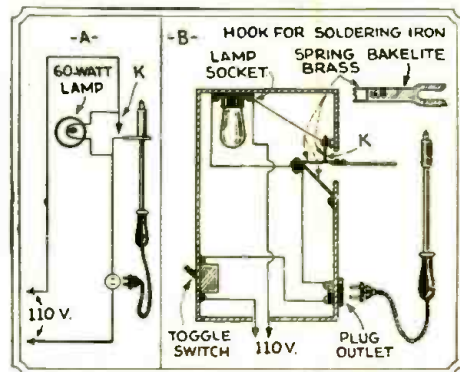

Fig. 3

A novel soldering iron holder. At A, its electrical circuit; and B, the mechanical arrangement.

## OPTIONAL DETECTOR CIRCUITS

By John C. Simorsin

FOR those experimenters who are still in doubt as to the relative merits of the "power" and "grid-leak" methods of detection, the following scheme should enable them to prove to themselves which is best for their particular receiver.

The general idea is depicted in Fig. 4. While the scheme is not new, nevertheless it affords an easy way to instantly switch from one type of detection to another. It consists of the ordinary detector circuit so connected with a double pole double throw switch, that when it is thrown to one side the grid leak and condenser are short-circuited and a negative bias is placed on the grid. When the switch is thrown to the other side, a positive bias of four volts is placed on the grid through the grid leak and condenser. By properly selecting the point K, the positive bias may be adjusted to any desired value.

The resistors R1 and R2 should be calculated from Ohm's Law for any plate voltage desired. The values shown are for a plate voltage of 140 volts. With S1 thrown to the right, a grid bias of 8 volts is obtained; when thrown to the left, the positive grid bias is 4 volts.

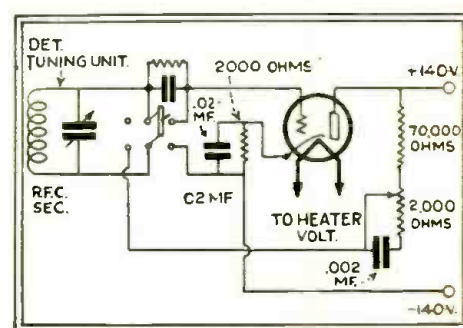

Fig. 4

A simple circuit for the experimenter; either grid or plate rectification is available.

# The RADIO CRAFTSMAN'S

The Bulletin Board for Our Experimental Readers

# Page

## DX ON THE PORTABLE

Editor, RADIO-CRAFT:

As per your invitation to let you know what results I obtained from the hook-up of the Pentode Portable described in the August issue of RADIO-CRAFT, I herewith enclose list of reception received on the first two evenings after building same.

I used an old Hammarlund S.L.F. .0005-mf. condenser with the Gen-Win tuner, and I note that the carton containing this tuner as received from the manufacturer reads "Use with .0005-mf. condenser" whereas instructions in the hook-up say use a .00035-mf. midget. However, I should be glad to have a diagram showing how to add a

screen-grid amplifier and another audio stage to this. The set is to be for 2-volt tubes.

Although I have been tinkering with building small sets for home use since 1922, I don't know much about theory, nor calculating values in ohms, microfarads, etc., also have been reading RADIO NEWS and RADIO-CRAFT almost since their inception and the name of "Gernsback" is a household one with me as far as radio is concerned.

For your further information, this place is a small town on the prairies 2,067 miles west of Montreal and 818 miles east of Vancouver, also about 200 miles straight north of Great Falls, Montana. There are no electric facilities here so that all radios are battery operated in this district.

G. M. McGUIRE,

Box 12, Acadia Valley, Alta., Canada.

(The enormous amount of correspondence that this department has received concerning the Portable Pentode receivers is a clear indication of the interest shown in portable apparatus. Some people labor under the delusion that in order to receive distance, it is necessary that large and elaborate receivers be employed. It is for the benefit of these pessimists that RADIO-CRAFT publishes in this forum a list of the stations received by Mr. McGuire on his RADIO-CRAFT Portable Pentode receiver.—Editor.)

(Continued on page 440)

## \$5.00 FOR BEST RADIO WRINKLE

RADIO set builders and experimenters often come across new radio wrinkles which may be beneficial to other set builders, experimenters, or Service Men.

RADIO-CRAFT will pay \$5.00 each month to the person submitting the best Radio Wrinkle connected with radio construction or experimentation.

Regular space rates will be paid for published Wrinkles that are not prize winners. All checks will be mailed upon publication.

The judges will be the editors of RADIO-CRAFT, and their decisions are final. Unused manuscripts cannot be returned.

Please pay strict attention to the following simple rules:

Write, or preferably type, on one side of the sheet, the best Wrinkle connected with radio set construction or radio experiments that you know of. Make simple illustrations to show the idea. You can send in as many Wrinkles as you please. Everybody is eligible except the employees of RADIO-CRAFT or their families. This contest closes on the 15th of every month, by which time all the Wrinkles must be received for the next month.

Send all contributions to Radio Wrinkles Editor, c/o RADIO-CRAFT, 98 Park Place, New York City.

## SERVICE SELLING "SUPERS"

(Continued from page 418)

### Servicing the Receiver

Considering the servicing of the 726 SW receiver, for instance, the procedure for the broadcast portion of the receiver will be gone about in the ordinary manner—that is, a test for the tubes and voltages in the receiver, a continuity test, the major portion of which would be obtained by the use of a set analyzer and tube tester, and the alignment procedure. In aligning a superheterodyne, it must be borne in mind that only by following one definite procedure will satisfactory results be obtained. This procedure involves, first, the alignment of the I. F. amplifier and, secondly, the alignment of the R. F. amplifier, first detector, and oscillator circuits. Other than to state that this is done in the conventional manner as described in many service bulletins with the aid of a small oscillator operating both in the broadcast band and the I. F. frequency, little need be said except in the specific matter of low-frequency oscillator alignment.

All Silver-Marshall service bulletins cover this process in a manner materially simpler and differing appreciably from that specified in most service bulletins. This method involves the align-

ment of the oscillator at the high frequency, or 1400 kc. point in the customary manner, but calls for the temporary substitution of an external condenser unit in place of the oscillator tuning section for 600 kc., or low-frequency alignment. This method has been covered in numerous articles by the writer, appearing in different radio publications in the past, and is specifically covered by Silver-Marshall service bulletins which are available, upon request, to all Service Men.

The matter of servicing the short-wave portion of such a receiver as the 726 is something that cannot be handled with ordinary test oscillators since they will not cover the frequency range involved, and it can therefore only be done at the present time by actual ear tests upon short-wave signals. However, if the broadcast band portion of the receiver is in satisfactory operating condition, there is little that can go wrong with the short-wave portion which cannot be located either by continuity tests or tests of fixed condensers by the customary charge and discharge method.

(Continued on page 442)



**SM**

The  
**SILVER-MARSHALL**  
All-Wave  
**726 SW**  
Brings them in!



"This is the first time I have ever written to a radio company regarding the marvelous performance of a radio receiver. Words cannot express the thrill I get when I operate my 726 SW. It is the greatest short wave receiver I have ever tried, and believe me, I have tried most of them.

"Only had the set ten days and have logged England, Holland, Rome, South American Stations, Cuba, and most of the Short Wave American Broadcast stations.

"Outside of the foreign stations I get a kick out of listening to Ship to Shore telephone messages, airport to airport, and plane to ground. Also most of the Police stations in the U. S. and Canada.

"The set is unbelievably sharp in tuning yet the tone is great."

Yours very truly,  
**BANK'S RADIO COMPANY**  
1247 South Kedvale Avenue  
Chicago, Illinois

This is just one of hundreds of letters Silver-Marshall has received from enthusiastic owners of the 726 SW.

Tubes required: 2-'24s, 3-'27s, 3-'51s, 2-'47s, 1-'80.

726 SW All-Wave Superheterodyne, complete, as described above, wired, tested, licensed, including S-M 855 electro-dynamic speaker unit. Size 20½" long, 12" deep, 8½" high. To be used on 110-120 volt, 50-60 cycle AC power. Price \$139.50 List.

**SILVER-MARSHALL, Inc.**  
6419 West 65th Street • Chicago, U. S. A.  
Canadian Division: SILVER-MARSHALL of CANADA, Ltd.  
75 Sherbourne Street, Toronto  
Export Office: 41 Water Street  
New York City, U. S. A.

**In the All-Wave 726 SW**

**Eleven-tube Short-Wave Super  
Nine-tube Broadcast Super  
No Plug-in Coils  
Pentodes in Push-Pull  
Sensitivity between .45 and .7  
microvolts per meter  
10½" Electro-Dynamic Speaker**

SILVER-MARSHALL, Inc.  
6419 W. 65th Street, Chicago, U. S. A.

Please send me full details on the S-M 726SW (enclosed you will find 2c).

Please send me FREE your new November General Parts Catalog.

Name .....

Address .....

# Radio-Craft's Information Bureau

## SPECIAL NOTICE TO CORRESPONDENTS: Ask as many questions as you like, but please observe these rules:

Furnish sufficient information, and draw a careful diagram when needed, to explain your meaning; use only one side of the paper. List each question.

Those questions which are found to represent the greatest general interest will be published here, to the extent that space permits. At least five weeks must elapse between the receipt of a question and the appearance of its answer here.

Replies, magazines, etc., cannot be sent C. O. D.

Inquiries can be answered by mail only when accompanied by 25 cents (stamps) for each separate question. Other inquiries should be marked "For Publication," to avoid misunderstanding.

### DOUBLE-PUSH-PULL-PENTODES

(141) Mr. J. L. Suter, Winchester, Ill.

(Q.1) I have an automobile public address system incorporating two type '47 pentodes in parallel on either side of a push-pull output stage, thus making four pentodes in all. The amplifier works well until we connect the "C" battery into the circuit. Immediately the volume and quality drop, and the amplifier starts an annoying singing. We have changed the input push-pull transformer, and varied the "C" bias from 4½ to 45 volts, without improving the operation. What is the trouble? Also, incidentally, the article by Mr. C. H. W. Nason, "An Ideal Sound System," in the August issue, was very interesting; what became of him in the September issue?

(A.1) The circuit used by Mr. Suter is reproduced in Fig. Q.141. It is noted that the filaments of the pentodes are connected in series-parallel, thus making it convenient to apply to the filament binding posts a potential of five volts; resistor R2 serving to drop it one volt. The input circuit is operating at a rather low volume level; a screen-grid tube as V1, or even an automotive type of general-purpose tube, the type '37 (the filament of which connects directly to the storage "A" battery, without the use of a limiting resistor) should greatly improve the operation.

If the previous articles, in the August and September issues, entitled "Pentodes and Their Use," by C. E. Denton, and the third instalment in the October issue, have not sufficiently enlightened Mr. Suter on corrective measures, we call attention to and recommend the use of, resistor R3 and its .05-mf. condenser.

Operation without the "C" battery in circuit sometimes indicates a soft or gassy tube; connection into the plate circuit at X1, of a milliammeter of suitable range, may be used as a means of indicating the best grid-bias potential for the particular plate potential available for the make of tubes selected—least fluctuation of the needle with audio modulation being the criterion.

Operating the amplifier with only two tubes in use in the push-pull circuit is the best "cut-and-try" method of checking the tubes for balanced characteristics; operation should be the same when the two tubes are interchanged in the sockets. Any difference in performance indicates either unbalanced tubes or unbalance in input or output transformer secondary or primary, respectively. Try shunting C1 with C2, thus leaving un-bypassed the low-potential end X2 of choke C11.2. (See "How's and Why's of Push-Pull Operation," by Edgar Messing, which appeared in past issues of RADIO-CRAFT.) It may be desirable to ground the cores of the audio transformers, and the secondary of T2, as indicated. Test for leakage between the transformer windings. Microphonic tubes may set up audible, sub-audible, or super-audible frequencies causing the troubles mentioned.

### R.F. TRANSFORMERS— "TYPE L CHECKER" TESTS

(142) Mr. R. Peck, Philadelphia, Pa.

(Q.1) I have been a reader of your radio journal since the first issue, and value the information contained therein. Will you kindly publish an article in the near future in RADIO-CRAFT on how to construct a modern radio tuner?

I have for the last few years built a number of all-electric sets for myself and my friends, using types '26 and '27 tubes in the R.F. stages. While they are giving good service, yet they are not as selective and not as sensitive as the modern receivers of the screen-grid type.

I have made several attempts to modernize the R.F. stages by using types '24 and '35 tubes, but have not been successful. The amplifier parts and power packs are still O.K., and need not be changed. There is enough "B" and "A" voltage in all these power packs to accommodate two or three more 2.5-volt tubes.

All I need, therefore, is a good constructional diagram showing the layout of parts, number of turns on coils, and sizes of all condensers, resistors, shielding, etc., for the construction of a good screen-grid type 2-stage R.F. tuner; including a power detector.

I believe if a manufacturer should put such a unit on the market he could do a good business, as there are many sets using the '26 and '27 type tubes, with good audio amplifiers, power packs, and dynamic speakers, but lacking the modern R.F. tuners and power detectors.

A unit of this type should be of great value to Service Men who modernize old sets.

(A.1) Mr. Peck's inquiry has interesting possibilities as a commercial proposition. However, as with most ideas, there exist flaws which make its application impracticable under certain conditions.

Most chassis designed within the last three years were built with a fine regard for available space, leaving little room in which to put an additional unit. Also, many power units are an integral part of the receiver design and cannot be divorced from the tuner section of the instrument.

In general, the statement may be made that any R.F. tuner, which is conveniently separated from

the test procedure is exactly the same as when a '12 tube is being tested. The difference in reading of the meter of the tester should be from 8 to 12.

For the type "L" tester, a 9451 adapter should also be used as described above. The minimum difference in the meter reading should be 9.

In any of the testers listed above, the procedure used in testing type '51 and '35 variable- $\mu$  tubes is the same as for the '24 tubes.

### BALANCING KELLOGG "B" CHASSIS

(143) Mr. H. M. Knapp, Watertown, N. Y.

(Q.1) Please advise as to the best method to be employed in balancing the Kellogg "Model B" chassis. There are several of these sets in town and we always have to ship them to the factory when they require balancing. It seems to me that a well-equipped shop should be able to align these correctly, if the correct procedure is made available.

(A.) In reply, the Service Department of the Kellogg Switchboard & Supply Co. very kindly submits the following detailed information:

"Service manuals covering Kellogg radios using Kellogg Type 401 and 403 tubes are entirely exhausted (The schematic circuit appears on p. 199 of the OFFICIAL RADIO SERVICE MANUAL, Vol. 1.—Tech. Ed.), but we offer the following paragraphs on the alignment and balancing of these models.

"A modulated oscillator tuning from 1500 to 550 kc. should furnish the signal, and an output meter should be connected at the audio output. (If this equipment is not available, circuit resonance may be satisfactorily obtained by tuning in two weak radio stations, one at either end of the band, and adjusting the aligning condensers of the detector and R.F. stages for greatest volume.)

"Each aligning or trimming condenser is located nearest its associated tube, and the balancing or neutralizing condenser is nearest the coil of each stage.

"After alignment of the resonant circuits has been secured, the balancing or neutralizing procedure is as follows: beginning with the R.F. stage nearest the detector tube, and using the shield top which has two holes perforated to allow the entrance of two neutralizing sticks, the top filament connector is removed from the R.F. tube in the stage being balanced, and, keeping the stage in best alignment, the balancing condenser is adjusted for weakest volume. On some stages no signal will be evident; this is the ideal point at which to leave the balancing condenser. Each succeeding stage is balanced in the same manner. After all stages have been balanced, the balancing condenser should not again be touched, but should be sealed with wax, or other suitable sealing medium. The receiver should now have its final resonance alignment and every stage including the detector should be aligned for greatest volume. The last step is to test the receiver by tuning in stations across the entire range, noting the selectivity and sensitivity.

"Kellogg receivers of the series using Kellogg Type 401 tubes rarely oscillate, and may be considerably out of balance without being near the oscillation point. Inductive tuning is used, the left-hand knob controlling zone-switch contacts which tap the secondary of each coil and divide it into seven zones. These contacts should be cleaned if oxidation or dust has accumulated on them and prevented perfect contact. This condition may be the diagnosis if the set fades and other possible causes have been checked and eliminated.

(Continued on page 440)

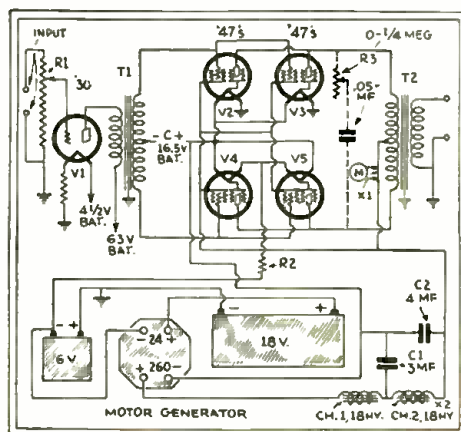

Fig. Q.141

Circuit diagram of the automobile receiver used by Mr. Suter. The use of a tone-control across the output transformer is recommended.

the audio system and power pack, may be replaced with any other R.F. system equally as flexible in circuit manipulation. Consequently, descriptions in past issues of RADIO-CRAFT of radio receivers incorporating screen-grid and variable- $\mu$  tubes, and a power detector circuit, should be applicable to any audio or power system of standard design and sufficient power rating.

Where difficulty is experienced, special corrective measures must be applied, the required steps depending solely upon the individual difficulty.

(Q.2) How may the Dayrad types "L," "B," and "C" checkers be modernized so as to be able to test pentodes and variable- $\mu$  tubes?

(A.2) For the type "B" and "C" testers, a 9451 adapter should be inserted in the '45 socket;





**PROOF**

# Over 25,000 Men have been trained under my supervision for the **Better Jobs in RADIO**

R. L. DUNCAN, President  
Radio Training Schools



As a graduate and a student under your supervision, I have only the highest praise and satisfaction to offer. Any man of ordinary intelligence wanting to learn Radio could not help but master it by your method of training.  
**GEORGE A. KRESS,**  
2297 Montclair Ave., Detroit, Michigan



I am a Projectionist in charge at the Andelus theatre, recently completed. You may quote me at any time or place; refer to me, if you wish, anyone who may be interested in this vast virgin field of all that pertains to Radio and its many allied industries, and I shall be delighted to champion honestly without any reservation, your courses.  
**A. H. STRENG,**  
3005 Woodburn Ave., Cincinnati, Ohio.



To study Radio under R. L. Duncan is to learn it properly and in a way that is pleasant and fascinating. Once again thank you for your kind assistance and helpfulness.  
**E. E. PRICE,**  
361 Coteau St., W.,  
Moose Jaw, Sask., Canada.



Although it has not yet been a year since I enrolled for a course under your excellent supervision, I have opened a Radio Service Shop that is effective, successful and profitable. People come for my services from everywhere.  
**RUSSELL PEARCE,**  
326-18th Street, Des Moines, Iowa.

**I**N hundreds of Broadcasting Stations . . . in Radio Manufacturing Plants throughout the country . . . in Radio Laboratories . . . in Wholesale and Retail Radio Stores . . . in Radio Servicing . . . in Sound Motion Picture activities . . . on hundreds of ships that sail the Seven Seas . . . and even in the latest Television developments—you will find ambitious men who have been trained under my direct supervision.

I have devoted the last twelve years exclusively to the training of men for all branches of Radio. Employers in the Radio field recognize my methods of qualifying men and young men. I have geared my training to the rapid growth and development of the Radio industry. My courses, text books, methods and equipment are based on years of practical experience.

And now, with the organization of my own independent Radio Training Schools, Inc., I am better prepared to help you than ever before, in training for the opportunities which the future of the ever-growing Radio industry will have to offer.

### You too can train for Future Success in Radio

The next few years will offer more prospects than ever before. The past several months offer positive proof that the trained man has the best chance. You still can get that training which will qualify you to gain a foothold in Radio. Study at home, in spare time, at minimum expense. Earn while you learn. Capitalize your idle and spare time and reap the benefits of a trained man in a progressive industry—Radio.

### Make your Idle and Spare Time Profitable

My courses include everything needed for thorough training. There are no "extras" or "specials" to cost you extra money. The lessons, text books, methods, correcting, grading and returning of examinations, all the extra help and personal consultation you need . . . everything is provided until you complete your training.

**RADIO TRAINING SCHOOLS, INC.**  
326 Broadway New York City

And in addition you are assured *practical* as well as theoretical training.

### Pick Your Branch of Radio

I am offering four distinct Radio training courses:

- 1. Talking Motion Pictures—Sound
- 2. Radio and Broadcast Operating
- 3. Practical Radio Engineering
- 4. Radio Service and Mechanics

Each course is complete. Each starts out with simple principles well within your grasp. Each is right up to date, including latest developments such as Television. Each prepares you for a good paying position. Each leads to a Certificate of Graduation.

### Advanced Training for Radio Men

My Practical Radio Engineering Course is an advanced course intended for Radio men who want to go still higher. It provides that necessary engineering background which, combined with practical experience, qualifies the man for the topmost job.

### Ask for Facts—Write Now!

Let me sit down with you for an hour or two at your convenience. Let's go over the possibilities in Radio. This we can best do by means of the book I have just prepared. It covers the many branches of Radio and the kind of training required. Be sure to get your copy . . . it is free.

**GET THESE  
FACTS  
T-O-D-A-Y**



Mr. R. L. DUNCAN, President  
Radio Training Schools, Inc.  
326 Broadway, New York City

Without incurring the slightest obligation on my part, please send me a copy of your latest book, "Facts About Radio."

Name \_\_\_\_\_  
Address \_\_\_\_\_  
City \_\_\_\_\_ State \_\_\_\_\_

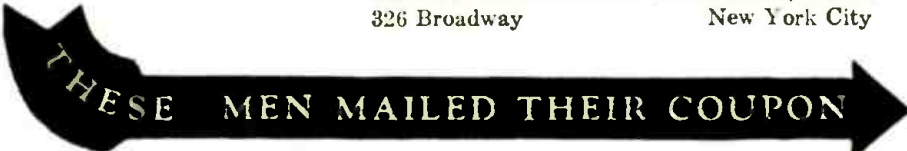

**FILTERMATIC PRODUCTS**

Help you to get the BEST possible reception from your RADIO set.



**SUPER-TONE CONTROL**

Will make your old Radio (battery or electric) equal in tone to the most modern set. Installed in one minute's time, no tools required. Will tune out much of your noise and so-called static. Will tune your set to suit your ears. Positively cannot harm the most radio in any way. Price, \$2.50 postpaid. Satisfaction guaranteed or money refunded.

**SUPER-FILTERMATIC The Modern Aerial**

Thousands of satisfied users, praised by radio experts. Replaces all other aerials, reduces static and noises. Especially good on distance reception. High to separate stations, does not connect in light socket (therefore eliminating hum and line noises). It is very compact, measuring only 1 1/2 x 2 inches, is absolutely non-corrosive and non-directional. Installed in one minute, no tools needed. Will never wear out. Eliminates troubles and expense of lightning arrester.



Price only \$2.00 postpaid

Satisfaction guaranteed or money refunded



ALL PROGRAMS are good with a FILTERMATIC. For all radios only \$1.00 postpaid.

Entirely automatic — no bothersome tuning. Improves tone, reduces static, brings in distance. Increases volume, separates stations.

Installed in one minute, no tools required, in series with your aerial or across your aerial and ground. Satisfaction guaranteed or money refunded.

Send check or money order, C.O.D. 25¢ with order. (No foreign C.O.D.) Money-back guarantee after 5-day trial.

Service Men and Dealers Write for Particulars, also information about FREE local newspaper advertising service.

**FILTERMATIC MFG. CO.**

(Dept. B-9) 4458 Frankford Ave., Philadelphia, Pa.

**New LONG & SHORT WAVE RADIO**

only \$79.50

COMPLETE with CABINET 9 TUBES DYNAMIC SPEAKER



Radio listeners are no longer satisfied with local reception. Short wave's the thing. They demand the thrills that come with distance—ships at sea, Australia, Germany, South America. Here is the newest thing in radio. One unit, broadcast band and short wave, in amazingly beautiful cabinet. No coils to change. Four-way switch regulates all. Guaranteed to bring in any station anywhere that can be brought in by any other radio regardless of cost and operated under same conditions. Everything complete for only \$79.50.

**AGENTS WANTED:** This amazing radio operation will make money for you fast if you write now. No competition at this price. The equal of any radio at any price. Get busy! If you want to make big money. Exclusive territory to those who qualify. My company the largest of its kind. Write quick. **BIG MONEY.**

P. H. WILCOX, Secretary

Surrey Court & Fullerton Dept. 2 Chicago

**SERVICEMEN!**

Resistor Replacement Manual

**FREE** with purchase of 10 Lynch Metallized Resistors, or \$1 cash MORE THAN 200 CIRCUITS

Gives the value and code of each resistor and its position in the circuit, of nearly every popular make of radio. SAVES TIME and experimenting.

**LYNCH Resistors**

Write for your copy today LYNCH MFG. CO., Inc., Dept. RC, 1775 B'way., N. Y.



**MICROPHONES**

SPECIAL NET PRICE LIST

- No. 300 Single Button Carbon Type Stretched Diaphragm ..... \$ 9.00
  - No. 301 Two-Button Carbon Type Stretched Diaphragm ..... 15.00
  - No. 302 Two-Button Heavy Duty Type ..... 30.00
  - No. 303 Two-Button Concert Model ..... 45.00
- Also complete accessories for public address work. Write for Catalog

Miles Reproducer Co., 26 E. 22d St., N.Y.C.

**THE AUTOVERTER**

(Continued from page 396)

former primary disconnected from the 6-volt supply until the rotating circuit-breaker has gained speed. An electrical refinement is the circuit arrangement which makes it unnecessary to take the filament current through this circuit-breaker and the power transformer. Two remaining units, the R.F. choke and the filter condenser, are shown at the left.

By a slight modification of the connections it should be quite convenient to operate the Radiette on a current supply of 110 volts D.C. This would call for a limiting resistor (a 110 volt lamp of correct wattage ordinarily is used) which would pass sufficient current to operate the autoverter, just as though it was connected to a storage battery. Naturally, care would have to be taken to prevent grounds—as when the metal chassis touches a radiator—but this method of operation would increase the utility of the Radiette by opening up the big New York, Chicago, and other markets where a great many hotels and homes are supplied with D.C. power lines.

The Radiette installation may be recommended on several grounds: it is very efficient (tests were conducted in Radio-Craft Laboratories), it presents a fine appearance, it is light in weight, and well constructed, and its components are of high grade. The Troubadour unit, or receiver chassis, is supplied with tubes. (The receiver shipped to Radio-Craft included a type 37 screen-grid detector which became slightly microphonic at high volumes)—the frequency response was exceptionally satisfactory. A pilot light illuminates the recessed, transparent tuning drum.

**Installation Data**

When the Troubadour chassis is to be operated from a lighting circuit, only the antenna is connected to the receiver. In some instances, however, operation may be a bit noisy unless the chassis is grounded through a fixed condenser of about 0.5-mf. capacity.

The method of installation in a car of course will vary with individual models. In general, most cars will require some form of interference suppression; a fixed condenser and a kit of special resistors are packed with the Radiette. (The use of these units has been discussed in numerous past issues of Radio-Craft.)

Although the use of suppressors will not impair the efficiency of an efficient ignition system, it may be that, in some instances, due to poor condition of the ignition system, unsatisfactory engine performance may result at low speeds. This, of course, should be a warning to repair the ignition system.

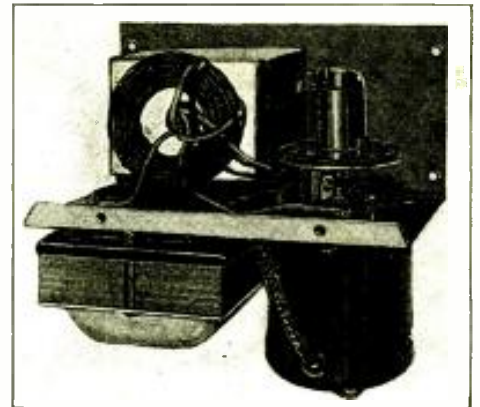

**Fig. C**

The "Autoverter," showing step-up transformer, filter, and motor-driven interrupter.

The type of car antenna to be employed is a matter which should be settled by an automotive radio technician who is familiar with the signal pickup characteristics of the various makes and models of cars.

The autoverter assembly is mounted in the car by bolts; the holes through which they run are bushed with rubber. The unit must be mounted with the motor shaft horizontal and the oil-cups upward. In case it is not definitely known whether the car bat-

(Continued on page 425)

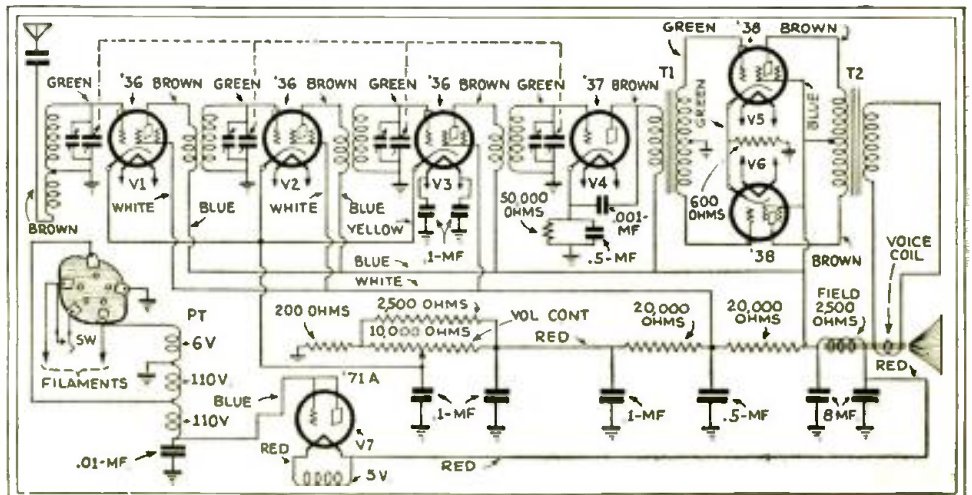

**Fig. 1**

Schematic circuit of the Radiette "Troubadour" chassis. The autoverter consumes 6A. at 6 V. (battery) and outputs 15 W. at 110 V., A.C. The filaments draw about 2.1; they connect directly to the battery for D.C. operation and to a 6-volt secondary for A.C.



## THOUSANDS OF BROADCAST STATIONS

ACCORDING to Hollis Baird, chief engineer of Short-Wave and Television Corp., engineering development in the field of ultra-short-waves, or those below 5 meters, is rapidly opening a field of study as thrilling as the original broadcast band of yesterday and today.—“To that great clan of men who bewail the loss of the good old days of 1920-1924 when life was worth living with so much experimental work to do at home, let me say that a new era is dawning and those who still have that spark of pioneering left in them now have a rich field for their experimental explorations.”

Since it is quite convenient to operate at these low wavelengths, radio transmitters and receivers designed for a frequency band *twenty times wider* than our present 200-500 meter band must be designed. Consequently there will be much work accomplished by the independent experimenter in working out suitable instrument designs.

Atop the Empire State Building in New York City, special ultra-short-wave equipment is being installed. This is particularly significant when we realize that ultra-short-waves, while affected by solid objects in their path, are not affected by static or fading, two of the greatest bugbears of “ordinary” radio waves; and that these super-short wavelengths can be received only within the optical range of the transmitter. Therefore, a high position for the transmitter is a direct advantage.

In the United States there are about 640 broadcast stations, with an average service area of perhaps 100 miles. Now, by reducing this to only the visible (optical) area, and increasing the number of transmitters, thousands of stations can be accommodated throughout the country, without overlapping.

### THE AUTOVERTER

(Continued from page 424)

tery has the positive or negative post grounded, the polarity should be determined either by a voltmeter or by inspection of the battery (the larger terminal is usually positive). For best results and long brush life the autoverter then should be connected as indicated at the terminals,—red, positive, and green, negative. To these two terminals also are connected a black and a yellow lead; the former grounds to the pressed iron chassis, and the latter connects to the grounded battery terminal. If the connections are correct there will be no voltage between the autoverter and the frame of the automobile.

To compensate for the drain of the Radiette, the battery charging rate should be increased to 15 or 18 amperes.

#### Service Information

The autoverter portion of the Radiette is fused at 20 amperes. A potential of 270 volts should be read between the chassis and the filament of the rectifier (red lead); and to “plus B” (blue), 160 volts. Voltages at the respective sockets are as follows:

Plate potential, V1 to V6, 160 volts; screen-grid potential, V1, V2, V3, 90 volts; V5, V6, 160 volts. Cathode potential, V1, V2, V3, 2 volts; V4, 10 volts; V5, V6, 16 volts.

# NEW LOW PRICES

—EFFECTIVE AT ONCE—

**I.R.C. TYPE “K”**

*Metallized*

## RESISTORS



For the first time in International Resistance Company's long and successful history, *Metallized Resistors* are now in the “low-price range.”

Our rapidly increasing volume has made this possible. The 1931 demand for the new Type “K” *Metallized* units went far beyond our sales of any previous year. We met this demand. We have increased our production facilities accordingly—and now, for 1932, are giving every purchaser the benefit in these substantial price reductions:

	Former Price	Now
I.R.C. RESISTOR GUIDE Price \$1.00 Given FREE with purchase of 10 Metallized Resistors		
1/2 Watt Resistors	50c List	30c
1 Watt Resistors	50c "	30c
2 Watt Resistors	75c "	40c
3 Watt Resistors	80c "	50c

The well-known I.R.C. standards in both materials and craftsmanship will be absolutely maintained as heretofore. I.R.C. units will be built to the same rigid and exclusive specifications that have made Type “K” *Metallized* the most widely used resistor in the radio field.

The new price schedules are in effect at once. See your favorite wholesaler—and when you buy, look for the I.R.C. label. That is the mark of the genuine.

Remember—with any assortment of 10 *Metallized Resistors*, you get free of charge our I.R.C. Resistor Replacement Guide. It gives all the resistor data you need about any popular receiver—the proper types and values to use in each set. Ask your jobber for it. Other I.R.C. service helps will be supplied as heretofore.

### INTERNATIONAL RESISTANCE CO.

PHILADELPHIA

—:—

—:—

TORONTO

INTERNATIONAL RESISTANCE CO., 2006 Chestnut Street, Philadelphia.

C-1

Gentlemen:

I enclose \$1.00 for which please send I.R.C. Resistor Replacement Guide.  
 Please send complete information on *Metallized Resistors*. I wish to purchase assortment of ten, entitling me to Resistor Guide Free.

Name .....

Address .....

City ..... State.....

# Study RADIO in CANADA



George McCollum

A. L. Norris, president, Norris Radio Co. writes: "My service manager, George McCollum, is one of your graduates. His excellent training has been largely responsible for the success of our Service Department."

## DAY, EVENING and HOME STUDY Classes

Complete, new Radio Course approved by leading manufacturers in U. S. A. and Canada. Our free Employment Service definitely assists you to start in a radio business of your own, or get employment as engineer, inspector, tester, service representative, salesman, etc. Write for free booklet

### RADIO COLLEGE of CANADA

Limited

310 Yonge Street

Toronto

## ACROCYCLE OSCILLATOR

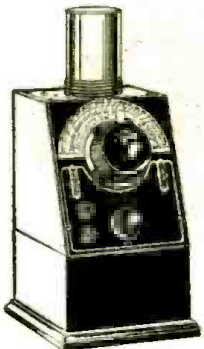

115 to 1680 kc. All frequencies accurately calibrated on dial. A dependable, high-grade instrument. Indispensable for aligning Super-Heterodyne receivers. Self contained, fully shielded. List \$30.00.

DEALERS' NET PRICE **\$17.50**

Handsome leatherette carrying case, net \$2.00.

Made by the manufacturers of the pioneer short wave adapter the SUBMARINE, now \$12.50.

If your jobber does not carry, order direct from **J-M-P MFG. CO., INC.** 3351 Fond du Lac Ave. Milwaukee, Wisconsin

## ALUMINUM BOX SHIELDS

Genuine "ALCOA" stock, silverdip finish. 5 x 9 x 6, \$1.89—14 x 6 x 6, \$3.85, 10 x 6 x 7 Monitor size \$3.25, 5 x 5 x 5 Coil Shield (like picture on right) \$1.00.



Any Size to Order.

## "BUDDY" TEST PROD

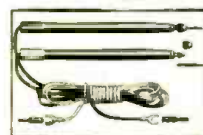

Always sharp pointed, using phonograph needles, 4-ft. wires, spade or phone tips. Colored nipples identify each lead. \$1.50 pair.

We specialize in radio parts exclusively—parts furnished for any kit in any magazine. Carrying Cases for Set Testers, Analyzers, Portable Sets

**BLAN, THE RADIO MAN, Inc.** 89 Cortlandt St. Dept. RC-132 New York, N. Y.

## BACK ISSUES

of RADIO-CRAFT can be had at the price of 25c each. Address **RADIO-CRAFT** 98 Park Place New York City

# LATEST IN RADIO

(Continued from page 398)

there are small-current, high voltage types for 1,000, 5,000 and 10,000 volt use. The fuse element is a small wire of suitable gauge. In Fig. D, "Gryp-Connectors" are illustrated, making connection to the fuses a convenience.

Instrument burnouts are due to heavy current overloads. The operation of these fuses is based upon the fact that at these overload figures they will blow out before the meter elements. This is clearly indicated in the table below (taken from oscillograph measurements made at 110 volts) which shows that instrument fuses may be designed which will fuse with extreme speed.

Filament of '99 tube.....	.038-sec.
115 ma. thermogalvanometer.....	.0035-sec.
0-1. ma. D.C. milliammeter.....	.173-sec.
1. A. Littlefuse.....	.013-sec.
1/4 A. Littlefuse.....	.003-sec.
1/32 A. Littlefuse.....	.001-sec.
1/100 A. Littlefuse	(Too fast to be recorded.)

Thus, the thermogalvanometer and the '99 filament would be saved by a 1/2-ampere Littlefuse, and the 1. ma. meter by the 1/32-ampere unit.

These fuse products are manufactured by Littlefuse Laboratories.

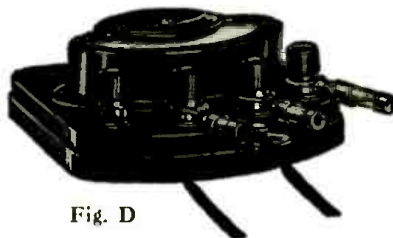

Fig. D

"Gryp-Connectors" and meter "Littlefuses."

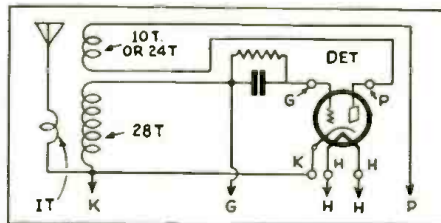

Fig. 1

The short-wave adapter described on page 398.

## RECENT NEON LAMPS

LATE model neon lamps will readily pass the tests for spotted glow surface, flaring or glowing outside the edges or behind the plate, high extinguishing or "bucking" voltage, short life, bulb surface blackening, and low limit of safe brilliance. Perhaps the most generally applicable test is to connect the tube to a potential source of 190 volts, D.C. The resulting glow should be a bright orange light, in an unbroken layer on the front of the plate and without flaring elsewhere.

The new tubes are illustrated in Fig. E. High space charge is avoided by the use of an alloy cathode with a processing on the surface, and proper annealing. Spot-

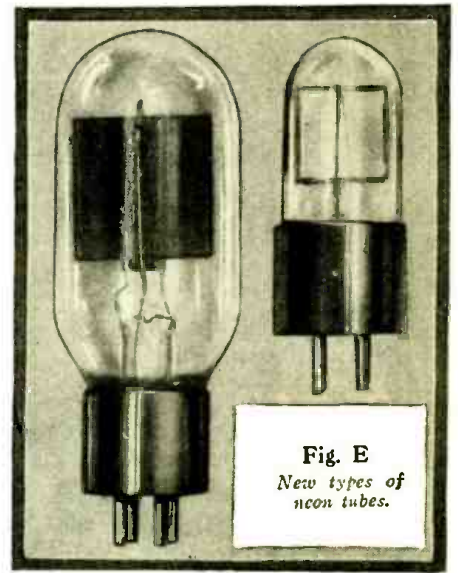

Fig. E  
New types of neon tubes.

free illumination is obtained by generous spacing between the electrodes and by proper gas pressure. The tube draws 25 to 30 ma. at 200 volts; its impedance is 15,000 ohms. One tube has a cathode 1 1/2 in. sq.; the other, 1 in. sq.

These new tubes are products of the Arco Tube Laboratories.

## LOW-PRICED SERVICE OSCILLATOR

A NEW design in service oscillators is the Pattern "563" instrument illustrated in Fig. F. This oscillator is shielded, and comes equipped with tube. It employs a type '30 tube in a self-modulated circuit. Improved battery life is obtained through the use of a 4 1/2 volt "A" battery and a rheostat.

The output of the Pattern 563 oscillator is continuously variable over three frequency ranges: 550 to 1,500 kc.; 125 to 185 kc.; 175 to 450 kc. This extremely wide frequency coverage is in line with the requirements of present-day T.R.F. and superheterodyne circuits. A feature of the instrument is the trimmer adjustment which allows any much used I.F. value to be "spotted" at a convenient point on the scale.

The Pattern 563 radio service oscillator is manufactured by the Jewell Electrical Instrument Co.



Fig. F

The Jewell Pattern "563" Service Oscillator.



# THE AAA-1 DIAGNOMETER

(Continued from page 399)

tage, screen-grid current, cathode voltage, control grid voltage, plate current, control grid current, etc.

In this instrument, all test circuits and meter ranges are available for external use, through bakelite covered pin jacks. Current ranges of 2.5, 10, 25, 100 and 250 ma. and 2.5 amperes are available for external use for either A.C. or D.C., using a copper-oxide rectifier type meter and an associated scale selector switch. This meter, often referred to as a multimeter, is another very important feature of the new Diagnometer. Due to the fact that it can be employed to read A.C. and D.C. potentials, its use results in an enormous simplification of a great many tests. Of course, the value of this unique meter is further enhanced by the design of the special selector switch.

An external A.C. and D.C. voltage range of 2500 volts is provided in addition to the A.C. and D.C. ranges of 2.5, 10, 25, 100, 250, and 1000 volts. The 2500-ohm-per-volt high resistance D.C. voltmeter ranges of 0-40 and 0-200 are also available through external connections for testing automotive and airplane radio installations.

### Mutual Conductance Method Used in Tube Tester

No analysis of a radio receiver is complete without a thorough check-up of the condition of its tubes. The tube tester incorporated in the AAA-1 Diagnometer employs what is known as the grid or mutual conductance index test. Tube engineers consider this test to be the most accurate of the several in general use. An oscillation test is also included, for matching tubes to be used in radio frequency stages. A gas test is provided for all amplifier types of tubes, indicating the gas content of the tube under test. In connection with the testing of cathode heater types of tubes, an ingenious cathode-heater leakage test is available, which shows whether or not the cathode is shorted to the heater and, in addition, also indicates leakages which could not possibly be shown by the usual "short" tester.

In addition to the two sockets provided for analyzing purposes, the instrument is equipped with five tube-testing sockets and also with the necessary switches for connecting the proper potentials to these sockets for tube tests. Potentials ranging from 100 to 240 volts, A.C., may be employed for the tube testing. A selector switch provides the means of selecting the correct potential. Since the tube checker is adjusted to the correct line potential, it is unnecessary to make use of complicated tube testing tables. Instead, a few simple test readings are sufficient for the various types of tubes and these are compared with values provided with the Diagnometer. A "filament-heater" selector switch is provided for all tubes having filament ratings from 1½ to 7½ volts. A great convenience from the standpoint of the Service Man is the fact that all the potentials employed in the tube tester are also available for external use. A pilot light is provided which indicates when the tube testing circuits are in operation.

### Modulated and Attenuated Oscillator Provided

Nowadays, a set analyzer without an accurate oscillator is of little use to the Service Man. He is often called upon to "peak" and "flat-top" the intermediate stages of superheterodynes, to synchronize, balance and neutralize tuned R.F. stages and to perform many other tests which are impossible without a good oscillator. The Diagnometer employs a completely shielded, modulated and attenuated oscillator which operates directly from the A.C. line. This oscillator is individually calibrated for all frequencies from 90 to 1500 kc. and, if higher frequencies are needed, they may also be obtained. The output of the oscillator can be controlled from maximum to an absolute minimum.

The Diagnometer resistance ranges are printed on the top scale of the multimeter. The ohmmeter will measure resistances of 0-5000-ohms range; and a megohmmeter measuring resistances up to 500,000 ohms, with a battery of only 4½ volts (the latter is five times the range coverage previously offered in resistance test units actuated with this size battery). By means of an external 45-volt battery, it is possible to extend the indicating range to 5 megohms. Continuity testing up to 25 megohms is possible through the use of a 250-volt D.C. connection.

A zero-ohm corrector is provided for adjusting the multimeter sensitivity to the battery or other power supply variations. Incorporated in the Diagnometer is an output circuit at 250 volts D.C. for the 25 megohm range; the same supply (in accordance with R.M.A. standards) is used in testing condensers for leakage.

The new Diagnometer is provided with means for making capacity measurements ranging from .002 to 10 mf. It can also be used to test paper condensers, applying 250 volts D.C. to them. This test will indicate leakage up to about 4 megohms.

The Diagnometer is shown in the two accompanying illustrations. Fig. A is an external view with cover open. The case is of substantial hardwood and the cover is of the slip-hinge type, with adequate room for the analyzer cable, test probes, small tools and other necessary accessories. The over-all size of this instrument is 6¾ in. x 11¼ in. x 18¾ in. and its weight is less than 24 pounds. Fig. B gives an excellent idea of the appearance of the inside of the Diagnometer. The instrument is supplied complete with all necessary accessories such as analyzer plug, cable, power supply plug and cable, output adapters and test leads.

There is one point which should be emphasized in connection with the use of the Diagnometer, and that is the fact that the instrument is very easy to use.

With each instrument is included a 100 page instruction book; in addition, there is available a special 85 page data book. Thus, there is no single point about this instrument which, though incorporating the most advanced engineering in service instrument design, is not clearly explained to the owner.

SUPREME INSTRUMENTS CORP.  
423 Supreme Bldg.,  
Greenwood, Miss.

Please send me full particulars on

(Here indicate instrument or instruments interested in)

Name .....  
Address .....  
City ..... State .....  
Name of Jobber.....  
City ..... State .....

## Be a Coupon Clipper

This one can bring real dividends from better service. Sign and mail it.



Prepare yourself for the challenge of 1932—the call for modern, perfect service—"Supreme" service. Let this coupon bring complete details on Supreme 1932 Testing Equipment, including the instrument that has set the whole service world agog. Complete . . . handy . . . versatile . . . positive . . . almost beyond belief.

## SUPREME DIAGNOMETER AAA 1

5 ultra modern testing instruments in 1 at the price of 1

DEALER'S NET PRICE, f. o. b. Greenwood, Miss. . . . .	\$147.50
SUPREME SET ANALYZER Model 90 . . . . .	78.50
SUPREME OSCILLATOR Model 70 . . . . .	49.75
SUPREME TUBE TESTER Model 40 . . . . .	30.00
SUPREME OSCILLATOR Model 60 . . . . .	30.00

Each a "gilt-edge" investment for more service dividends. Clip coupon—mail, after indicating instrument on which data is desired.

Ask Your Jobbers to Demonstrate

Distributors in All Principal Cities

FOREIGN DIVISION

130 West 42nd St. New York City  
Cable Address: Lopreh, New York



# MERCURY VAPOR RECTIFIERS

(Continued from page 401)

potential of the gas. We have therefore, in this device, a means for getting higher output of both current and voltage, and making this gain in efficiency available in external circuits.

There are certain fundamental considerations which must be observed to correctly adapt a mercury-vapor tube to power pack design; considerations which differ considerably from those which we associate with type '80 tube engineering.

For instance, the output of a type '80 rectifier may feed directly into an inductance, as shown in Fig. 1, or it may be fed into a capacity CI, as indicated by the dotted lines; the mercury-vapor tube, however, demands a capacity input,—that is, the latter dotted connection. This circuit, which results in high current-output, rather than high voltage, is the preferred method of operating the tube; although, of course, the inverse peak potential reaches a high value, or approximately three times that of the average or D.C. potential.

(neglecting their current considerations). Thus, we have a simple method of reducing a receiver's tendency to oscillate at sub-audio frequencies,—“motor boating.”

### Adaptation of the Rectifier

For the reference of the technician, additional data are given on the adaptation of the mercury-vapor rectifier.

For instance, as a substitute for the type '81 or half-wave rectifier, the circuit shown at A, Fig. 2, must be followed. Here we find a new “trick” in circuit arrangement, the use of resistor R3; as one of two plates of a type 588 tube, when connected in parallel with the other, draws more current due to the fact that the filament is at a potential  $2\frac{1}{2}$  volts higher with respect to one plate than to the other. Consequently, by using Ohm's Law, we find, if the load current is 250 ma. (125 ma. per plate), then

$$RI = \frac{2.5}{.125} \text{ or } 20 \text{ ohms.}$$

It must be remembered that while this resistance serves to maintain at the same value the difference of potential between the filaments and their respective plates, the filament must be correctly poled with respect to the filament transformer, in order for the plate to function equally.

Note this fact particularly, in regard to the use of two type 588 tubes in a half-wave connection. The current rating is practically double that of a single tube, but the voltage rating is the same; and resistors R3 should be 2.5 volts divided by one-fourth the total load current. This circuit is recommended for use in big radio receivers or public address amplifiers.

A power pack designed for two '81's may be rewired to use a single 588, as shown at C, Fig. 2. The power output will be the same, with the improved regulation obtainable from the latter as an added advantage. Resistors R4, 1.25 ohms each, are required to drop the filament potential from 7.5 volts (secondary potential) to 5 volts (tube-terminal potential).

Additional data concerning the characteristics and use of mercury-vapor tubes are contained in Perryman Engineering Bulletin No. 100, which is available gratis either from the Perryman Electric Co., Inc., or through RADIO-CRAFT.

## SERVICING AMPLIFIERS

(Continued from page 403)

These directions cover all the normal faults experienced with Loftin-White amplifiers, and, with their aid, it should be a comparatively simple matter to restore this type of amplifier to operating condition. In order to enable the Service Man to check against normal conditions in these amplifiers, correct voltages for the circuit of Fig. 1 are given below.

Normal Voltages: 0-1, 10 volts; 2-1, 8 volts; 0-2, 2 volts; 3-1, 16 volts; 4-1, 36 volts; 5-1, 135 volts; 7-5, 250 volts; 5-8, 25 volts\*; 8-1, 30 volts\*; (\*Misleading, due to current drawn by meter).

### Replacing the '80

Let us take an average case, and note just what happens when the mercury-vapor type PR-588 tube is substituted for the high-vacuum type '80, in a power pack.

We shall continue to use Fig. 1, for reference, and take for the example a potential at the load resistor or standard (15,000-ohm) voltage divider R1, a potential of 270 volts; and a total current drain, read at X2, of 100 ma. (for convenience, this current figure is taken to represent the total drawn by the receiving tubes and the voltage divider when the receiver is in operation); the rectifier, V1, is an '80. Substituting for this tube one of the 588's, the voltage across R1 jumps to about 300, and the current will increase about 2 ma. This should not cause the voltage divider to burn out unless it was being operated much too close to the safety factor; since this current increase would be divided between the requirements of the tubes and the bleed or current consumption of R1. What might happen, however, in some poorly designed sets is circuit oscillation, due to the increase in the potentials applied to the various circuits of the receiver.

To remedy this situation, a series resistor could be inserted in the rectified power-supply circuit at X1; in the instance cited, a 300-ohm resistor would bring the potential across R1 back to the original figure of 270 volts.

Have we gained any advantage by making this change? To this natural question, an affirmative answer may be given, since the mercury-vapor rectifier tends to maintain a constant current in its output circuit. This action may be likened to the result obtained when “regulator tubes” are used. As these must not be operated at potentials exceeding 90 volts, three of them would be required, as shown in dotted lines, V2; however, by the use of the type 588 tube, inherent in which is this regulating action, we are able to obtain, at 270 volts, a regulating action otherwise obtainable only through the use of three type 874 regulator tubes

## SERVICE MEN Send for this Book

# FREE!



**YOU NEED IT!**  
Everything for your business from the finest mike to the smallest screw is in this book.

**GUARANTEED QUALITY GOODS**  
**PRICES LOWEST EVER QUOTED**  
Fresh new dependable Merchandise at Bargain Prices!  
Leading Manufacturers Lines Complete  
Send For Your Copy Now!  
**SAMPLE BUYS FROM THIS BOOK**

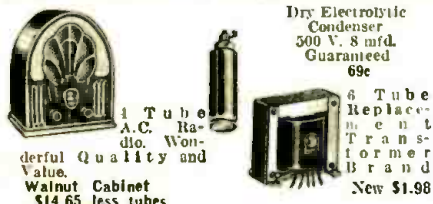

Dry Electrolytic Condenser  
500 V. 8 mfd.  
Guaranteed  
69c

6 Tube Replacement Transformer Brand  
New \$1.98

1 Tube A.C. Radio. Wonderful Quality and Value.  
Walnut Cabinet \$14.65 less tubes

and Three Thousand Other Bargains  
**HEADQUARTERS**  
for **SERVICE MEN'S SUPPLIES**

# RADOLEK CO.

601 W. Randolph St.  
**CHICAGO**  
Illinois

Radolek Co.,  
611 West Randolph St.,  
Chicago, Ill.

Please send me without obligation your Service Man's Supply Book.

Name \_\_\_\_\_  
Address \_\_\_\_\_  
City \_\_\_\_\_ State \_\_\_\_\_

## Universal Microphones

Proved Value—Superior Performance

Unparalleled values at rock-bottom prices. Enthusiastically endorsed for every sound use. Exclusive design features. Super-careful workmanship. Tested performance.

Complete line of microphones, stands, cables, etc., at challenging prices. Unconditionally guaranteed. Consider carefully the UNIVERSAL line before you buy. For sale by dealers everywhere.

2-Button Handi-Mike  
List Price \$15

BABY MIKE  
List Price \$7.50



Universal Microphone Co., Ltd.  
1163 Hyde Park Blvd.  
Inglewood, Calif., U.S.

## SHORT WAVES

HOW TO BUILD AND OPERATE  
SHORT-WAVE RECEIVERS

This book has been edited and prepared by the editors of SHORT-WAVE CRAFT, and contains a wealth of material on the building and operation, not only of typical SHORT-WAVE RECEIVERS, but SHORT-WAVE CONVERTERS as well.

Dozens of short wave sets will be found in this book, which contains hundreds of illustrations; actual photograph of sets built, hook-ups and diagrams galore.

Send 50c in check, money order or stamps for your copy.

SHORT WAVE CRAFT

98 Park Place New York City



# SELECTIVITY

(Continued from page 404)

channels separated by 10 kc. from one another. This does not mean that there is a definite space in which the response characteristic of a receiver may overlap without running into interference, for, as it was shown that a station at 1000 kc. modulated at 5000 cycles has side-bands between 995 and 1005 kc., a station on 990 kc. has side bands extending from 985 to 995 kc., and a station at 1010 kc. has them between 1005 and 1015 kc. The spectrum is thus occupied continuously, as shown in Fig. 4. If, however, we could design a circuit of a type having a response characteristic of ideal character—rectangular in form—we might have an extremely poor numeric selectivity.

In Fig. 2, the response of a "band-selector" is shown in comparison with the ideal. Note that the wide response at the peaks has no effect upon the adjacent channel selectivity whatever—it is the *peelings* of the response curve where it slopes outside the ideal demarcation that will affect the adjacent channel selectivity of the receiver. A multiple arrangement of coupled circuits or "band-selectors" will aid in obviating this difficulty, since the numeric selectivity still enters into the arrangement. The problem may also be solved by the use of coupled circuits in the intermediate system of the "super" which operate at the 175 kc.

By means of careful design and by the use of a number of coupled circuits we have won out over the two related problems of *numeric* and *adjacent channel selectivity*. But we have not finished—for the superheterodyne has a little trick of its own awaiting us.

### Image Frequency Selectivity

It is easy to understand that if a local oscillation of 1175 kc. will interact with a signal of 1000 kc. to produce a 175 kc. resultant, that the same local oscillation interacting with a signal of 1350 kc. will also produce a signal of 175 kc. Under such circumstances, the intermediate frequency amplifier will find itself with two signals of 175 kc., and will amplify both without discrimination. What? You say that the receiver is tuned only to the 1000 kc. signal? That is quite so—but if the 1350 kc. signal were from a powerful local, a certain amount might leak through the preliminary tuned circuits to the first detector and if the 1000 kc. signal were weak and distant, the 1350 kc. signal might well appear at the first detector equal in intensity to the desired signal. The only answer is the inclusion of a high degree of numeric selectivity prior to the first detector. It is for the sake of this needed selectivity more than for need of the additional gain, that the modern superheterodyne receiver has a stage of radio frequency amplification ahead of the first detector.

### Cross Talk and Beat Interference

Because of certain effects, even this first R.F. tube requires consideration of the amount of selectivity included in the circuits between it and the antenna. We have found

that there are three distinct kinds of selectivity insofar as the modern receiver is concerned; but there are two more factors to discuss before we can close the issue entirely.

An overloaded tube, or a tube operated with a large negative bias, has a remarkable number of frequency components in its output. Modern receiver designers must bear this in mind in working out their problems. The output of the second detector has large components of the second and third harmonics of the intermediate frequency. Higher order harmonics—the fourth, fifth, etc.—are of low intensity and need not be considered. The intermediate frequency of 175 kc. was chosen, among other reasons, for the fact that none of its harmonics of lower order than the fourth, are of broadcast frequency, and consequently feed-back of harmonics from the detector output to the antenna cannot affect the receiver.

If a strong off-frequency local station introduces a high voltage across the grid of the first R.F. tube which is sufficient to operate it on a portion of its characteristic favorable to the production of harmonics, etc., modulation of the desired signal by the harmonics of the undesired local signal will take place, with the result that the final undesired modulation will be superimposed upon the desired one. Where this occurs in the plate circuit of the first tube, no amount of selectivity in subsequent circuits can remove it. This means that it is necessary to have a certain proportion of our selectivity included in the circuits between the antenna and the grid of the first R.F. stage.

Again we must consider the fact that two strong local signals can beat together in the tube circuits to produce additional components in the same manner that the superheterodyne produces a 175 kc. signal. Thus a signal at 550 kc. and another at 710 will have components of 160 and 1260 kc.—the latter frequency lying within the broadcast band. Characteristic of such a signal is the fact that it carries the double modulation of the two stations superposed one upon the other. Such an admixture occurs in the tube circuits and not in the antenna, consequently the effect may be avoided, as shown before in the case of cross-talk between a desired and an undesired signal, by the inclusion of a high order of selectivity between the antenna and the grid of the first tube.

Selectivity has been shown to be definable under three different premises, as, numeric, adjacent channel, and image frequency selectivity; and the latter definition applying to superheterodyne receivers only. The two effects of cross-talk and beat interference have also been shown to demand the inclusion of a definite kind of selectivity in the circuits. Selectivity has then become something quite different from what it was originally supposed to be, and the attempt to achieve the ideal characteristic in the response of receiver systems can be said to have led to a situation where selectivity (adjacent channel) and quality run hand in hand.



Send  
for this free  
Centralab  
book on  
Fixed Resistors

We have just published a very interesting booklet telling how CENTRALAB Fixed Resistors are made.

This will be sent to you without cost or obligation. Use the coupon . . . now!

**Centralab**  
CENTRAL RADIO LABORATORIES

930 E. Keefe Ave., Milwaukee, Wis.

Mail the Coupon Today

CENTRAL RADIO LABORATORIES  
930 E. Keefe Ave., Milwaukee, Wis.  
Please send me your Free booklet "A Baptism of Fire."

Name .....

Address .....

City ..... Province .....  
Radio-Craft

# PORTABLE SOUND RECORDERS

(Continued from page 414)

factor in overcoming microphone fright with the result that better records are made. The potential possibilities in this field are quite apparent when it is observed that every single family is a good live prospect, not for just one call but for repeated calls.

At parties, portable recording has proved itself to be a great source of entertainment and, at the same time, a big money-maker for the person making the recordings. In the past it has been the custom for the

host or hostess to buy souvenirs to give their guests as mementos of the occasion, but now portable recording steps in to give the guests the thrill of hearing their voices as others hear them and at the same time gives them a living record of the occasion. Appropriate labels for the records can be made for the party souvenirs, which will give them a sort of exclusiveness so that the host will feel that he is giving to his guests something personal rather than just a disc.

At banquets, speeches can be recorded for the speakers themselves or for the guests, while at church fairs and bazaars, recording booths can easily be set up and business solicited in much the same manner as at studios. Students of music, who in the past have been reluctant to go to the studio for recording on account of the inconvenience of carrying their instruments, are excellent prospects, because the studio can now be easily brought right into their own homes

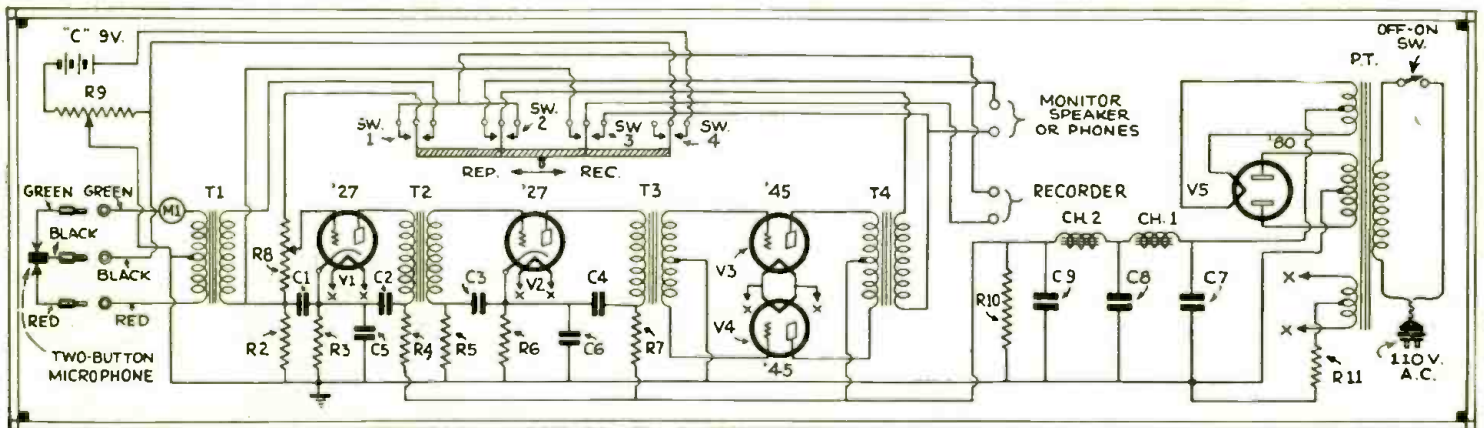

Fig. 1

Schematic circuit of the equipment within the amplifier case of the Portable Sound Recorder. Microphone current readings for either button are obtained by reversing the position of the plug of the 3-conductor cord. The filtering shown is very important.

# Thinking of Making *EXTRA* Money in spare time?

Servicing Electric Refrigerators Brings Many Easy Dollars

\$5.00 The Copy

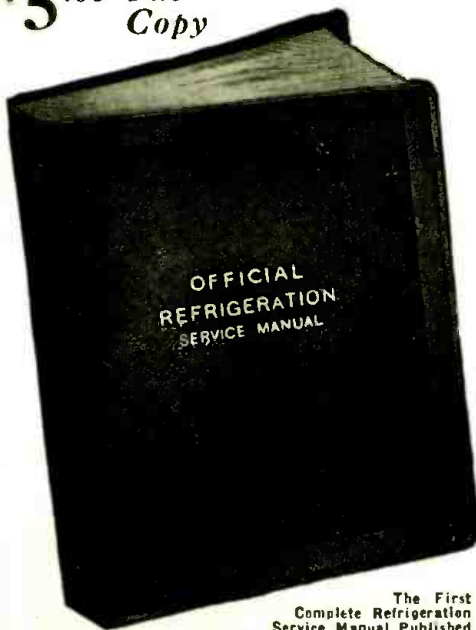

THE idea of electricians, radio service men and other mechanically inclined men, servicing refrigeration units is self-evident and the thought has occurred to perhaps untold thousands ever since electric refrigeration started. Yet nothing was done, because the average man knows little or nothing about refrigeration. Compared with servicing a radio set or wiring a home for electricity, the servicing of a refrigerator is absurdly simple, once you get the hang of it.

The OFFICIAL REFRIGERATION SERVICE MANUAL has been edited by L. K. Wright, who is an expert and a leading refrigeration authority. He is a member of the American Society of Mechanical Engineers, American Society of Refrigeration Engineers, The National Association of Practical Engineers, etc.

In this Refrigeration Manual every page is profusely illustrated; every refrigerator part is carefully explained; diagrams are furnished of every known machine; special care is given to the servicing end. The tools needed are illustrated and explained; there are trouble shooting charts, and other service data.

Remember there is big money in the refrigeration servicing business. There are thousands of firms selling refrigerators every day and they need to be cared for often. Eventually there will be more refrigerators than radios. Why not increase your earnings with a full or spare time business by servicing refrigerators.

- Here are some of the important chapters:
- Introduction to the Refrigeration Servicing Business
  - History of Refrigeration
  - Fundamentals of Refrigeration
  - Description of All Known Types of Refrigeration
  - Service Tools and Shop Equipment
  - Motors
  - Trouble Shooting
  - Unit Parts, Valves and Automatic Equipment
  - Makes and Specification of Units
  - Manufacturers of Cabinets
  - Refrigerants and Automatic Equipment
  - and Many other Important Chapters.

Already hundreds of copies of the OFFICIAL REFRIGERATION SERVICE MANUAL have been sold; and there still remains the greatest opportunity for thousands more to learn how to make more money in a short time through openings in this new field.

*Mail Coupon Today!*

GERNSBACK PUBLICATIONS, Inc. RC-132  
96-98 Park Place, New York, N. Y.

I enclose herewith my remittance for \$5.00 (check or money order preferred) for which you are to send to me, postage prepaid, one copy of the OFFICIAL REFRIGERATION SERVICE MANUAL.

Name .....

Address .....

City ..... State .....



with no inconvenience to them. It is readily seen that visits of this nature can become a regular part of the student's courses.

One of the most unique applications of the portable service is the recording of wedding ceremonies. By the use of a double turntable, the complete ceremony can be easily recorded and the writer has been informed by one firm that is doing this sort of work, that not one single bridal couple approached has refused to have their ceremony recorded.

The above applications are just a few of the money-making off-shoots of recording. There is no doubt that an enterprising and energetic technician can find many more uses for portable recording that will also prove profitable.

**Compactness**

Any portable recording apparatus should be made so compact that it is not bulky in carrying. It should be so light that whoever is to carry it can do so without undue effort. It should be sufficiently rugged to withstand the many jars of transportation without any mechanical or electrical damage being done. Finally, the units should be so arranged that they can be connected together with certainty in a minimum of time. The equipment should be capable of picking up, amplifying, and recording a fairly wide band of frequencies (the frequency response curve of the amplifier should be substantially flat, because of the necessity of making voice recognition possible).

The three-stage amplifier illustrated in Figs. A and B consists of three separate units, each built upon a separate panel with all the panels being the same in size. These units are supported one over the other by four threaded steel rods which pass through holes at the corners of the panels.

This construction has several important advantages. Any unit which becomes defective or out of date may be easily replaced. There is a minimum of unoccupied space because the parts of one panel may be arranged to fit down into the unoccupied space of the others. As examples of this, note the by-pass condensers on the bottom of the middle unit and the switch on the upper unit, Fig. B. The metal framework

is used for the common ground connection in the system.

The lower unit is the power supply; the middle unit, the three-stage amplifier; and the top unit, the switching panel which holds the microphone input transformer and current-indicating meter. Two '27-type tubes are used in the first two stages, and two '45-type tubes are used in the push-pull power stage.

The chokes in the power supply were carefully chosen for weight, size, and resistance. The latter figure must not exceed 300 ohms per choke to permit a satisfactory voltage supply. An electrolytic condenser was used for filtration because it combines small size and weight with high capacity.

Four wires connect the power supply to the amplifier. The two outer leads supply '27 and '45 filaments. The two inner wires between the lower units are the plus and minus of the "B" supply. The minus connection is used in addition to the framework for the sake of certainty.

As shown in the diagram of the amplifier, Fig. 1, the grid and plate circuits of the tubes are isolated from each other electrically by a condenser and resistance filter network. This results in the greatest possible amplification without circuit oscillation. All of the important wiring in the three units is made with shielded wire, with all of the shields grounded. This precaution is absolutely necessary in the switching panel.

Note the angle at which the microphone transformer is tilted in the upper panel, Fig. B. This is for reducing the A.C. hum picked up from the power transformer and chokes. This microphone transformer is as far from the power transformer as it was possible to locate it. With the transformer as shown, the hum picked up is sufficiently small not to be noticeable.

The switching arrangement is such that in one position the various units are connected for recording, and in the opposite position they are then connected for playing back the record through a speaker. In either the playback or the neutral position, the battery circuit supplying the microphone is open. The milliammeter is connected permanently in one of the microphone legs.

*(Continued on page 432)*

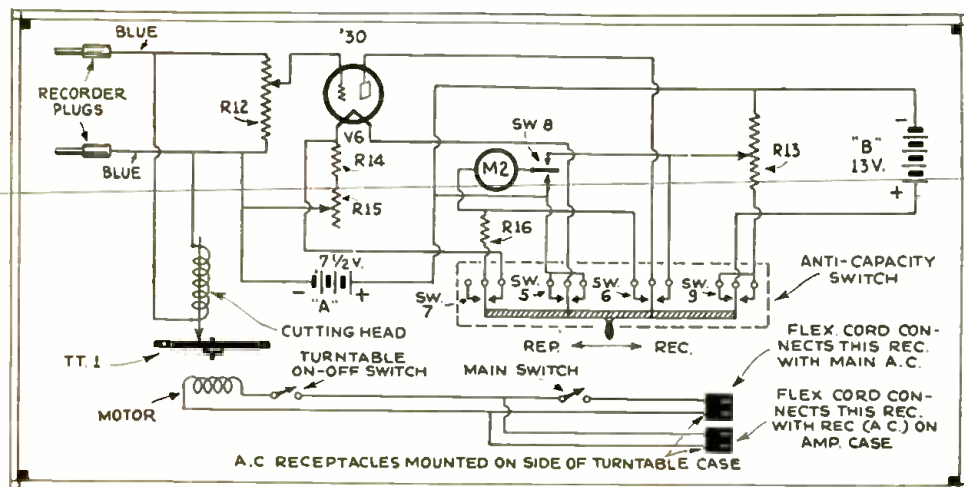

Fig. 2

Connections within the turntable case of the Portable Sound Recorder. Tube V6, in conjunction with meter M2, is a volume level indicator.

**CROSLLEY**  
New Pentode Output, Variable Mu  
**SUPERHETERODYNE**



**\$36<sup>36</sup>**

Complete with Tubes

The Crosley  
**LITLFELLA**

See the NEW CROSLLEY LITLFELLA—a 5-tube table model SUPERHETERODYNE radio receiver, incorporating big set features yet housed in an exquisite cabinet of choice walnut veneers, 17 inches high. Pentode output, variable Mu tube, full floating moving coil dynamic speaker, continuous (stepless) static and tone control, combined volume control and on-off switch. Illuminated dial with vernier drive—such features as these make The Crosley LITLFELLA the greatest of all radio values. Only \$36.36 complete. Also The LITLBOY, a 35" hobby model with same type chassis selling for only **\$48.50** Complete with tubes

Push-Pull Pentode Output  
**SUPERHETERODYNE**



The Crosley  
**PLAYBOY**  
8 TUBES

**\$49<sup>75</sup>**

with 8 Tubes Complete

An exquisitely designed all wood compact table model, 17 inches high, housing the new Crosley 8-tube push-pull Pentode output, variable Mu, Superheterodyne chassis with latest type Crosley full floating moving coil dynamic speaker. Two five-element Pentode output tubes connected in push-pull; two variable Mu tubes; continuous (stepless) variable static and tone control; illuminated hairline shadow dial with vernier drive; combined volume control and on-off switch; full floating moving coil dynamic speaker. Priced amazingly low. Also console models. The CHEERIO at \$56.00. The MERRY MAKER at \$75.00, the ANNOUNCER at \$85.00, the PLAYTIME (Electric Clock Model) at \$95.00, incorporating the same type SUPERHETERODYNE chassis, complete with tubes. Never before such radio values!

Push-Pull Pentode Output  
**SUPERHETERODYNE**  
with METER TUNING AND  
Automatic Volume Control



The Crosley  
**TENSTRIKE**

**\$69<sup>50</sup>**

Complete with 10 Tubes

An unusually attractive and powerful table model radio receiver incorporating the 10-tube push-pull Pentode Output, variable Mu, SUPERHETERODYNE chassis with METER TUNING and Auditorium Size Crosley full floating moving coil dynamic speaker. Stump walnut veneer front panel with burr marble overlay. Top, sides and pillars of walnut finish. Dimensions: 20 1/2" high, 16" wide, 10" deep. Also a magnificent six-legged console model with same type chassis at **\$99.50** Complete with 10 Tubes

*(Western Prices Slightly Higher)*

**THE CROSLLEY RADIO CORPORATION**  
POWEL CROSLLEY, JR., President  
Home of "the Nation's Station"—WLW Cincinnati



# Learn Chemistry

## Dr. Sloane Will Teach You in Your Own Home

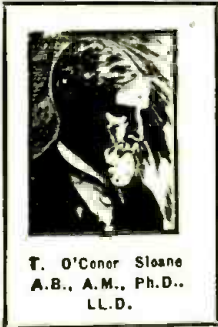

Chemistry offers those who are ambitious and willing to apply themselves conscientiously, the greatest opportunities of any vocation today. Industrial firms of all kinds pay tempting salaries to get the right men. Opportunities abound on every hand.

### Now Is the Time to Study Chemistry

Never before has the world seen such splendid opportunities for chemists as exist today. In factories, mills, laboratories, radio and electrical shops, industrial plants of all kinds, chemistry plays a vital part in the continuation and expansion of the business. No profession offers such opportunities and the next ten years are going to show the greatest development in this science that this country has even seen.

### You Can Learn at Home

Our home study course, written by Dr. Sloane himself, is practical, logical and remarkably simple. It is illustrated by so many experiments that are performed right from the start that anyone, no matter how little education he may have, can thoroughly understand every lesson. Dr. Sloane will, in addition, give you any individual help you may need in your studies.

### Easy Monthly Payments

You do not have to have even the whole price of the course to start. You can pay in small monthly amounts, earning the cost as you go along. The tuition is very low, and includes your laboratory outfit—there are no extras to buy with our course.

### Experimental Equipment Given to Every Student

We give to every student without additional charge his chemical equipment, including fifty pieces of laboratory apparatus and supplies and forty-two different chemicals and re-agents.

### Tuition Price Reduced

Besides furnishing the student with his Experimental Equipment, we have been able, through the big increase in our student body, to reduce the cost of the course. Write today for full information and free book. "Opportunities for Chemists."

### Mail the Coupon NOW!

## CHEMICAL INSTITUTE OF NEW YORK, Inc.

HOME EXTENSION DIVISION

19 Park Place New York, N. Y.

CHEMICAL INSTITUTE OF NEW YORK.

Home Extension Division  
19 Park Place, New York, N. Y.

Please send me at once, without any obligation on my part, your free book "Opportunities for Chemists," and full particulars about the Experimental Equipment given to every student. Also please tell me about your plan of payment.

NAME .....

ADDRESS .....

CITY ..... STATE .....

RC-132

# THE TELEPIANO

(Continued from page 402)

each key circuit of the receiving piano is provided with a signal sustaining device which maintains the current in the key-actuating solenoid during one revolution of the commutator brush, the process being repeated as long as the broadcast artist holds any key or keys down; for long or for staccato notes.

The broadcast artist can modulate any desired note at will by an additional mechanism, the details of which are not shown in the diagram for the sake of simplicity. Thus, for the first time in the mechanical piano field the music with slow crescendo, etc., effects is rendered exactly as played. This type of modulation requires an additional set of contacts, shown in Fig. 1, and also in Fig. B adjacent to the arm of the inventor, Mr. Watson.

The new invention will be marketed in several forms or models. An attachment will be sold to present owners of pianos, the keys of which are seldom dusted at present and less often played. Then there will be the complete Radio Telepiano delivered intact. Probably the most popular form will be a compact, keyless instrument in a

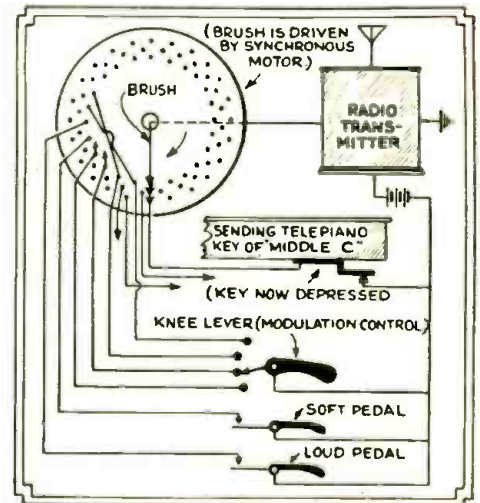

Fig. 1

Circuit arrangement of the "Telepiano."

cabinet somewhat like the better-class radio set of today, and such an instrument would be highly desirable for those music-lovers who must conserve space, notwithstanding.

## PORTABLE SOUND RECORDERS

(Continued from page 431)

To read the current in the other leg, it is only necessary to reverse the microphone plugs.

The amplifier is cushioned from mechanical shock by means of sponge rubber underneath and on the threaded steel rods.

The carrying case is of black imitation leather. The dimensions are 9 x 12 x 18 in., and the total weight is about 30 pounds.

### Turntable and Level Indicator Case

The volume indicator panel is located in the turntable carrying case so as to minimize the number of wires between the amplifier and the recorder.

A 250,000-ohm potentiometer, R12, Fig. 2, is used for varying the input signal to the tube, thus controlling the swing of the indicating needle. This potentiometer is purposely located inside the case so that once the setting is made, there is no chance of accidentally changing it. A 50-ohm rheostat, R15, controls the filament voltage on the level indicator, while the plate voltage is controlled by a 10,000-ohm potentiometer, R13.

In this turntable case are located two ordinary plug receptacles connected in parallel. One of these connects to the main lighting circuit, while the other supplies A.C. to the amplifier. The output of the amplifier is connected to the cutting-head by means of a cord and plugs, the latter being colored blue to differentiate them from the three microphone plugs which are red, green, and black. The color system is used to facilitate the making of the connections when speed in setting up is necessary. Phone receptacles are provided in the amplifier for monitoring purposes.

The dimensions of this case are 9 x 13 x 18 in., and its total weight is about 25 pounds. It is made of the same material as the amplifier case and one man can easily carry

both of these cases.

This about concludes the discussion of this money-making branch of recording, and the writer invites any correspondence pertaining to Instantaneous Recording. Write only on one side of the paper and enclose a self-addressed stamped envelope.

### List of Parts

(AMPLIFIER)

- One Jewell, 0-50 ma. milliammeter, M1;
- One Thordarson microphone transformer, T1;
- One Sangamo 1st stage A.F. transformer, T2;
- One Sangamo push-pull input transformer, T3;
- One Sangamo push-pull output transformer, T4;
- Two Electrad 20,000-ohm resistors, R2, R5;
- Two Electrad 1,000-ohm resistors, R3, R6;
- One Electrad 30,000-ohm resistor, R4;
- One Electrad 50,000-ohm resistor, R7;
- One Electrad, ¼-meg. potentiometer, R8;
- One Electrad 10,000-ohm potentiometer, R9;
- One voltage divider, R10;
- One Aerovox 2-section condenser unit, 2 mf. and 200 v. (per section), C1, C3;
- One Aerovox 2-section condenser unit, 2 mf. and 400 v. (per section), C2, C4;
- One Aerovox filter condenser block, 2, 4, 8 mf., respectively, C7, C8, C9;
- Two Thordarson filter chokes, CH1, CH2;
- One Thordarson power transformer, PT1;

(Turntable Case)

- One Electrad ¼-meg. potentiometer, R12;
- Two Electrad 50-ohm resistors, R14, R15;
- One Akra-Ohm 10,000-ohm resistor, R16;
- One Electrad 10,000-ohm potentiometer, R13;
- One turntable and feed-screw, TT1.
- One Jewell, 0-5 ma. milliammeter, M2;



## A BEGINNER'S SET ANALYZER

(Continued from page 410)

sistor, and adjust so that type '80 tube reads not quite full scale before button is pressed. Using a 15-ma. scale (as we did) the resistor was adjusted to make a good type '80 tube read about 13 ma.

Four sets of leads are required as follows: An A.C. 2-wire cable terminating in plugs at either end; a set of test leads, comprising two wires terminating in plugs; a screen-grid test lead terminating in a screen-grid clip at one end and a panel plug at the other; and a standard 5-wire analyzer cable.

### List of Material

- One A.C. outlet socket;
- Three 5-hole tube sockets;
- Four 4-hole tube sockets;
- One meter (used 0-5 ma.; recommend 0-1 ma.);
- One phone jack;
- Seven pin jacks;
- Two push buttons;
- Four D.P.S.T. push button switches;
- Two D.P.D.T. jack switches (Sw. No. 1 and No. 2);
- One power transformer made out of old Freshman transformer;
- One rheostat 200—250 ohms R1;
- One 400-ohm resistor R8;
- Two 10,000-ohm resistors R1 and R2;
- One 40,000-ohm resistor R3;
- One 60,000-ohm resistor R4;
- One 2250-ohm resistor R5.

### PHOTOELECTRIC SORTING

**L**ATEST on the list of accomplishments of the light-sensitive cell is its use in a machine for sorting file cards.

Accounting departments will find this "one-eyed robot" an effective assistant. The machine, designed by Douglass A. Young of the Westinghouse Electric and Mfg. Co., was developed in response to a demand for a machine which would sort and file bill stubs at the rate of several thousand per day.

Previous methods of sorting included the use of punch marks in locations coded for the particular routing to be obtained. The limitation of this method is the number of combinations possible,—only a few hundred. The new photoelectric method makes available, according to Mr. Young, over 100,000,000 combinations,—on a card measuring only 1½ x 3¼ in. long (still leaving sufficient room for the name and address of the customer)!

In a few words, the photoelectric method of card sorting may be described as a system of selection through the operation of a number of relays actuated by the light reflected into a single photoelectric cell from a card carrying along one side of a surface a number of short, black lines. These are arranged as to frequency and relative spacing in accordance with the predetermined coding for a given routing of the file card.

This opens a new field of installation and maintenance by the man who is familiar with photoelectric cells and their associated apparatus.

# MORE MONEY for Radio Service Men

Many service men could double their incomes if they knew how to go about it. There are tricks in all trades and radio service offers tremendous possibilities. Often a hint from an old-timer will make hundreds of dollars for you. Here is a book which you can have for the asking—a book which every radio service man should read. It tells you how to make more money out of radio service. There are secrets which "old timers" have learned through years of experience. You can have the benefits of these. You don't pay a penny—you don't promise to pay any—for this book will be sent to you without any obligation of any kind with our compliments if you will sign and send in the coupon. It is part of our plan to help independent radio men profit by the experience

of others in the industry and make a bigger income.

### Brim Full of Facts

This book was written by a man who has probably had more experience than any one else in the industry. It tells you in simple language the principles and practices which made him the outstanding figure in the radio world that he is today. These are a few of the subjects fully covered: Selling the public on radio service—Value of Personality—Newspaper advertising—Business literature—Types of service letters—Electric signs—Making tubes business builders.

This book is for service men only and will be sent FREE and fully prepaid upon receipt of the coupon completely filled in.

### Radio Service Men's Guild

The work now being done by the Radio Service Men's Guild is not for profit. It was undertaken because of the need for practical business training for radio service men. You can help by sending in suggestions. The offer made below is entirely without cost to you. There are no dues—no payments of any kind. It is done for the "good of the service."

only and will be sent FREE and fully prepaid upon receipt of the coupon completely filled in.



**RADIO SERVICE MEN'S GUILD**  
1261 Fullerton Avenue  
Chicago, Illinois

You may send me your book "Making Money Out of Radio Service" absolutely FREE and fully prepaid. (Please answer these simple questions):

What radio training have you had?.....  
 No. of years in radio?.....  
 Do you give radio all your time?.....  
 Have you a store?.....  
 Do you work for some one else, if so whom?..  
 Name .....

### SHORT-WAVE STUFF!!

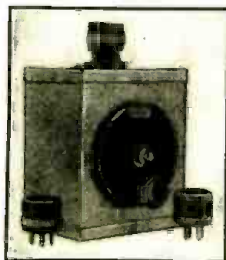

**SHORT-WAVE WAVE-METER.** Simple to Use. Makes stations easy to find. Range: 15 to 250 Meters. Accurate. Shielded. Calibration Remains Constant. Checks Regenerative Receivers, Coil and Condenser Ranges, Transmitters, etc. Complete Waveneter, with Coils, Calibration Chart and Full Instructions List, \$15. Your Special Price, Postpaid, \$8.95. Ham-Band Meter. Like above, ¼ of 1% accuracy. With Calibrated Coil for any One Ham Band, \$6.95. Add

\$2.00 for each extra Band desired. **BUILD A SHORT WAVE AND TELEVISION SET** Using a Set of our COMPLETE PLANS listed below: One-Tube Set (Also shows how to use this set as Adapter, or superhet Converter), \$9.00. \$10 Two-Tube Set (Also shows 3-Tube Hookups), \$15.00. Latest Four-Tube Set with Pentode, \$25.00. One-Stage R. F. Amplifier, connect ahead of Any Short-Wave Set, 10e. Two-Stage R. F. (TUNED) same as one-stage but 2 tubes, 50e. Adapter Plans, 35c. 10 Pages Plans for \$2. Short-Wave Transmitter, \$5.00. All the Dope! **EASY TO BUILD! TOTAL: \$4.10.** All of Above Plans, \$2 in Bills. First Three Above, \$1 Bill.

### DELFT RADIO

524 Fairbanks Ave.

Oakland, Calif.

### RADIO DEALERS RADIO SERVICEMEN NEW

### Radio Handbook

CONTAINING:

Technical Information.  
Volume Control Guide.  
Transformer and Condenser Guide.  
Radio Replacement Parts Catalog.

Sent postpaid anywhere for only

25 Cents

Specials from our Catalog

Atwater Kent 37 Block with chokes } \$2.95  
 Atwater Kent 27 Transformer, ea. }  
 Majestic Super "B" Eliminator Block } \$2.10  
 Electrolytic 2 anode Condenser, ea. }

Hard to Get Parts—We have them.  
Send us your Repair work for estimate.

### Grant Radio Laboratories

6519 South Halsted Street, Chicago, Ill.

# MAGIC IN METERS

(Continued from page 407)

**Hot off the press!**  
**The NEW RADIO and TELEVISION**  
**DATA DIGEST and ANALYSIS**



**Complete Specifications and Detailed Facts About All the New Lines . . .**

This condensed Radio and Television Digest contains all details as to What's New in Radio and Television for the season 1931-1932. Every radio dealer, wholesaler, manufacturer, mechanic, service man and radio fan will want one or more copies.

It contains complete specifications on everything in radio, such as prices, sizes, types (including midget and automobile radios), speakers, tubes, cabinet dimensions and the names and addresses of radio set manufacturers together with their trade marks. In fact everything that is required to keep abreast of the rapid changes and developments in the industry.

**Every Radio Man Needs a Copy**

It makes little or no difference which branch of the radio industry you are actively engaged in or whether you are just a radio enthusiast, you will treasure your copy of this valuable book. It may be used as a buying guide or a selling guide,—as a service guide or as a trouble shooting guide. As a matter of fact its uses are so universal that you will wonder how you ever got along without one when you have once put yours to use.

**The Only Book of Its Kind**

We know of no other source of information that is so concise and valuable to the progressive radio man. It tells at a glance who makes radios with electric clocks,—who makes midget receivers and all there is to know about them,—what receivers are featuring, automatic tuning,—what types of tubes the new models are using,—what television sets are on the market. In fact, nothing in radio need go unanswered from the moment you get your copy of this marvelous book.

National Radio Trade Directory, Dept. O  
 Fourth Ave. and 23rd St., N. Y. City.

Here's my two dollars. Reserve a copy of your 1931-1932 Radio and Television Data Digest and Analysis for me and let me have it as soon as possible.

Name .....

Address .....

City ..... State.....

Business .....

Company .....

Position .....

internal resistance as compared to a D.C. instrument; consequently, care must be used in the selection of the series resistor since its power rating must be taken into consideration. The resistor should have a power rating of at least twice the power consumed in order to insure constant accuracy over extended periods of time.

The formula used to find the value of the series resistor, as shown in Fig. 1, is used for A.C. as well as for D.C. meters.

A.C. meters may be used to measure potential difference both in A.C. and D.C. circuits. When A.C. meters are used in D.C. circuits, polarization of the magnetic parts of the instrument may cause erroneous results; therefore, two readings should be obtained, one with reversed polarity, and the average of these two readings used as the correct value.

**Power Rating of Multipliers**

In D.C. milliammeters having a range of 0-1 milliampere, the power rating of the series resistor is low. Referring to Fig. 8 where it was found that the value of  $R_m$  was 499,980 ohms or approximately 500,000 ohms, it will be instructive to determine the energy dissipated in this multiplier; using the formula

$$P = I^2 R, \text{ we find}$$

$$P = .000001 \times 500,000$$

$$P = 0.5\text{-watt.}$$

In this case, a stock resistor rated at one watt would prove satisfactory.

The lower sensitivity of alternating current meters with their lower values of internal resistance places a greater current demand on the series resistor. The Jewell model "78" 0-15 volts A.C. meter has an internal resistance of about 750 ohms and a sensitivity of 50 ohms-per-volt. To multiply this scale so as to indicate 150 volts, the scale reading must be increased 10 times. The value of the multiplier is

$$R_m = 750 \left( \frac{150}{15} - 1 \right)$$

$$R_m = 750 \times 9$$

$$R_m = 6,750 \text{ ohms.}$$

Since the total internal resistance of the meter is 750 ohms, and the maximum range is 15 volts, then

$$I = \frac{15}{750} = 0.02\text{-ampere}$$

as the current consumed by the meter.

If the multiplying resistance is 6,750 ohms, and the current consumed for full scale deflection is 0.02-ampere, then the power dissipated

$$P = I^2 R$$

$$P = .0004 \times 6750 = 2.7 \text{ watts.}$$

This resistor should have a rating of about 5 watts, especially where the multiplier is used in an enclosed case with poor ventilation. In cases where a resistor is used, whether it be in series or shunt with a meter, care should be taken to keep the

power dissipated through the resistor below its rated value.

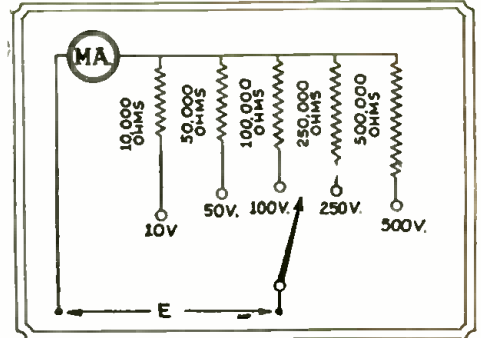

Fig. 10

A voltmeter of the "1,000-ohms-per-volt" type; unit M.A. is a 0-1 ma. milliammeter.

**Condensers as Multipliers**

Capacitors as multipliers may only be used in alternating current circuits. The circuit of Fig. 11 shows the multiplying capacity  $C$  in series with the meter  $A$ ; the resistance of the meter is indicated at  $R_v$  and the reactance of the condenser  $X_c$ . For 60-cycle work, the inductive reactance of the meter may be ignored, the total impedance of the series circuit becoming

$$Z = \sqrt{R_v^2 + X_c^2}$$

$X_c$  being the reactance of the condenser in ohms and is found from the formula

$$X_c = \frac{1,000,000}{6.28 \times f \times C}$$

$$\frac{250}{15} = 16.6.$$

One of the best ways to find the value of capacity required is to first obtain the multiplying ratio. For instance, it is desired to increase the range of meter  $V$ , Fig. 11, having a voltage scale of 15 volts and a resistance of 750 ohms, to 250 volts; the multiplying factor is

Since the resistance of the meter is 750 ohms, and the multiplier ratio is 16.6, then the reactance of the condenser must be 16.6 x 750 or 12,450 ohms.

The capacity of the condenser then is

$$C = \frac{1,000,000}{6.28 \times f \times X_c} = \frac{1,000,000}{376.8 \times 12,450} = 0.2\text{-mf.}$$

The total circuit impedance may be found from the formula

$$Z = \sqrt{750^2 + 12,450^2}$$

$$Z = 12,479 \text{ OHMS}$$

To determine the multiplication ratio as a check for accuracy,

$$\frac{Z}{R_v} = \frac{12,479}{750} = 16.6.$$



Thus we find our results check with our original calculations and, providing that the capacity of the condenser is as indicated on the label, satisfactory readings will be obtained as long as the frequency is not changed.

Another version of a universal meter has been developed by the engineers of the Shallcross Mfg. Co., using the circuit shown in Fig. 12. This arrangement results in a meter which can be used both in D.C. and A.C. circuits with voltage ranges of 5, 10, 50, 250, 500 and 1,000 volts; and current ranges of 1, 5, 25, 100 and 500 milliamperes.

All voltage scales have a sensitivity of 1,000 ohms-per-volt, and the current scales operate on a five-volt drop.

A single pair of binding posts is provided, and the various current and voltage ranges are controlled by the switches. The change from A.C. to D.C. measurements is made by the switch A.C.-D.C. The change from current to voltage measurements is made by the switch "MA." or the voltage selector switch "V."

If the switches are not properly set, a cautionary deflection of the needle will be noted, or else the fuse will blow. Otherwise, the safety key may be pressed and the measurement obtained. The danger of destroying a meter by failure to reset switches when changing from one application to another is minimized in this circuit by the cautionary deflection, the fuse, and the safety key.

**REFERENCE TABLE**

For the convenience of Service Men, the following information concerning the resistors associated with various types of commercial meters is given.

The first value given is the range for a particular type of meter; the second is the value of the internal, or external (indicated by \*), associated resistor for the stated range.

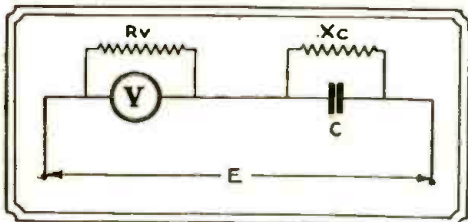

Fig. 11

This illustrates the use of condensers as A.C. meters multipliers. Resistors Rv and Xc are merely symbolic of V and C, respectively.

**Jewell Model 88 D.C. Milliammeter**

Scale Range 0-1 ma., resistance value (approx.) 30 ohms; 0-1.5 ma., 30 ohms; 0-2 ma., 25 ohms; 0-3 ma., 20 ohms; 0-5 ma., 12 ohms; 0-10 ma., 7 ohms; 0-15 ma., 5 ohms; 0-25 ma., 3 ohms; 0-50 ma., 1.5 ohms; 0-75 ma., 1 ohm; 0-100 ma., .75-ohm; 0-150 ma., .5-ohm; 0-200 ma., .37-ohm; 0-250 ma., .3-ohm; 0-300 ma., .25-ohm; 0-500 ma., .15-ohm.

**Jewell Model 78 A.C. Milliammeter**

Scale Range 0-25 ma., resistance value (approx.) 250 ohms; 0-50 ma., 120 ohms; 0-75 ma., 35 ohms; 0-100 ma., 15 ohms; 0-150 ma., 6 ohms; 0-200 ma., 3 ohms; 0-300 ma., 1.5 ohms; 500 ma., .7-ohm.

**Jewell Model 78 A.C. Ammeter**

Scale Range 0-1 amp., resistance value (approx.) .2-ohm; 0-1.5 amps., .15-ohm; 0-2 amps., .06-ohm; 0-2.5 amps., .05-ohm; 0-3

amps., .022-ohm; 0-5 amps., .007-ohm; 0-10 amps., .004-ohm; 0-15 amps., .002-ohm; 0-20 amps., .001-ohm; 0-30 amps., .001-ohm; 0-40 amps., .001-ohm.

**Jewell Model 78 A.C. Voltmeter**

Scale Range 0-1.5 volts, resistance value (approx.) 10.5 ohms; 0-3 volts, 21 ohms; 0-5 volts, 50 ohms; 0-10 volts, 160 ohms; 0-15 volts, 750 ohms; 0-20 volts, 1,000 ohms; 0-25 volts, 1,250 ohms; 0-30 volts, 1,500 ohms; 0-50 volts, 4,000 ohms; 0-75 volts, 6,000 ohms; 0-100 volts, 8,000 ohms; 0-150 volts, 15,000 ohms; 0-300 volts, 30,000 ohms; 0-500 volts, 50,000 ohms; 0-750 volts, 75,000 ohms; 0-1,000\* volts, 100,000 ohms. (\* External resistors.)

**Jewell Model 78 A.C. Voltmeter (double range)**

Scale Range 0-3 volts, resistance value (approx.) 48 ohms; 0-15 volts, 240 ohms.

**Jewell Model 88 D.C. Voltmeter**

Scale Range 0-3 volts, resistance value (approx.) 300 ohms; 0-5 volts, 500 ohms; 0-8 volts, 800 ohms; 0-10 volts, 1,000 ohms; 0-15 volts, 1,500 ohms; 0-20 volts, 2,000 ohms; 0-25 volts, 2,500 ohms; 0-30 volts, 3,000 ohms; 0-50 volts, 5,000 ohms; 0-75 volts, 7,500 ohms; 0-100 volts, 10,000 ohms; 0-150 volts, 15,000 ohms; 0-300 volts, 30,000 ohms; 0-500 volts, 50,000 ohms; 0-750 volts, 75,000 ohms; 0-1,000 volts, 100,000 ohms; 0-1,500 volts, 150,000 ohms.

**Weston Model 301 Milliammeter**

Scale Range 0-1 ma., resistance value (approx.) 27 ohms; 0-1.5 ma., 18 ohms; 0-2 ma., 18 ohms; 0-5 ma., 12 ohms; 0-10 ma., 8.5 ohms; 0-15 ma., 3.2 ohms; 0-20 ma., 1.5 ohms; 0-25 ma., 1.2 ohms; 0-30 ma., 1.2 ohms; 0-50 ma., 2 ohms; 0-100 ma., 1 ohm; 0-150 ma., .66-ohm; 0-200 ma., .5-ohm; 0-300 ma., .33-ohm; 0-500 ma., .2-ohm; 0-800 ma., .12-ohm.

**Weston Models 476 and 528 A.C. Milliammeters**

Scale Range 0-15 ma., resistance value (approx.) 200 ohms; 0-25 ma., 520 ohms; 0-50 ma., 120 ohms; 0-100 ma., 21 ohms; 0-250 ma., 4 ohms; 0-500 ma., 1.1 ohms.

**Weston Model 506 D.C. Milliammeter**

Scale Range 0-1.5 ma., resistance value (approx.) 18 ohms; 0-5 ma., 8.5 ohms; 0-10 ma., 3.2 ohms; 0-15 ma., 1.5 ohms; 0-25 ma., 2 ohms; 0-50 ma., 1 ohm; 0-100 ma., .5-ohm; 0-200 ma., .25-ohm; 0-300 ma., .16-ohm; 0-500 ma., .1-ohm.

**Weston Models 476 and 517 A.C. Ammeters**

Scale Range 0-1 amps., resistance value (approx.) 203-ohm; 0-2 amps., .05-ohm; 0-3 amps., .024-ohm; 0-5 amps., .01-ohm; 0-10 amps., .0058-ohm; 0-20 amps., .00162-ohm; 0-30 amps., .0007-ohm; 0-50 amps., .00057-ohm.

**Weston Models 517 and 476 A.C. Voltmeters**

Scale Range 0-1.5 volts, resistance value (approx.) 3 ohms; 0-2 volts, 4 ohms; 0-3 volts, 6 ohms; 0-5 volts, 10 ohms; 0-10 volts, 14 ohms; 0-15 volts, 14 ohms; 0-25 volts, 26 ohms; 0-50 volts, 52 ohms; 0-150 volts, 105 ohms; 0-250 volts, 166 ohms; 150/8/4 volts, 67/10/10 ohms (only in Model 476).

The Weston Model 301 D.C. Voltmeter is manufactured with two types of movements, one having a sensitivity of 62 ohms-per-volt, and the second, of 1,000 ohms-per-volt.

The Weston Model 301 D.C. Ammeters operate on a voltage drop of 50 millivolts up to 50 amperes range.



*Readrite*

No. 550

**OSCILLATOR**

(Licensed by A. T. & T. Co.)

**\$18** Net to dealer \$30 list      **\$21** Net to dealer with output meter

*If not at your Jobbers, we will ship direct when remittance accompanies order.*

A sturdy modulated instrument carefully made. Completely shielded with separate battery compartment. Furnished with 22½-v. and 3-v. batteries. Also one '30 tube. Direct reading broadcast band (550-1500-k.c.) and intermediate band (120-185 k.c.). Sharp 2d and 3d harmonics for 260-475 k.c. Operating instructions attached in case cover with shielded wire leads. Very compact. In leatherette case, 6 x 11½ x 5½ in. Weighs but 8 pounds. Built to high standards.

Every serviceman should have the No. 550 oscillator to align r.f. gang condensers, locate defective r.f. transformers, adjust i.f. transformers, check oscillator stage and determine sensitivity of a receiver. A necessary instrument. Get yours today. Write for catalog of servicing instruments.

**Readrite Meter Works**

*Established 1904*

17 College Ave., Bluffton, Ohio



GREATEST MAGAZINE IN TELEVISION



**TIMELY** developments in radio's latest wonder, television, are published in every issue of TELEVISION NEWS—Mr. Hugo Gernsback's latest magazine. Rapid advancement in this art today is becoming a repetition of the radio cycle of years ago. Daily broadcasts are becoming more numerous and experimenters are following in quick order in building television sets for experimental purposes. Foresight of its development can be seen by the pioneers of radio—they are equipping themselves now with television experience.

The articles published in TELEVISION NEWS are of primary importance to experimenters—they are simple in construction, understandable and replete with diagrams, photographs and illustrations.

**Interesting Articles in the Current Issue**

- The Future of Television.
- Build Your Own Cathode Ray Tube Scanner.
- John Logie Baird Speaks His Mind.
- A Prize-Winning Television Receiver—How to Build It.
- A Drum Scanner—How it Works.
- A First Class Television Amplifier With All Construction Details.
- Constructing a 5 Meter Receiver for the New Ultra-Short Wave Stations.
- An Experimental Kerr Cell.

**SPECIAL OFFER COUPON**

TELEVISION NEWS RC-132  
98 Park Place, New York, N. Y.

I enclose herewith my remittance of \$1.25, (Canada and foreign \$1.50) check or money order preferred, for which you are to enter my subscription to TELEVISION NEWS for One Year, also send me the last two issues gratis. I understand that the regular subscription rate is \$1.50 and this offer will be void after December 31. TELEVISION NEWS is published every other month.

NAME .....  
ADDRESS .....  
CITY..... STATE.....

**OPERATING NOTES  
SERVICING RADIOLAS**

(Continued from page 409)

After an examination, I attributed the trouble to the balancing of the three tuned stages. By changing the balancing screws, I found that if I set the dial on some station such as KDKA, I could bring in the station with good volume but could not receive any other station with any volume. The detector stage seemed to be the offending one. As long as I set the dial on some weak station and then turned the balancing screw of the detector stage I could get the station perfectly. The screw had to be turned until it was very tight. After many trials and failures, I loosened the screws holding the stator plates and moved the whole section of stator plates slightly to one side. When the balancing screw was loosened and adjusted on some station I found that all of my troubles were over, for the set worked perfectly from one end of the dial to the other.

On this same model, if the station comes in better when the shield can is lifted slightly from its socket, it is a pretty sure sign that the set is out of balance. The balancing screws are located in the front of the chassis.

**STATIC REDUCTION**

(Continued from page 405)

**List of Parts**

- Four broadcast coils, L1, L2, L3, L4;
  - Four variable condensers (to match the above coils), C1, C2, C3, C4;
  - One trimmer condenser, C1A;
  - Two hand-selector coupling condensers, .0001-mf., C5, C6;
  - One grid coupling condenser, .0005-mf., C7;
  - One antenna insulating condenser, .002-mf., C8;
  - One ground insulating condenser, .002-mf., C9;
  - One output coupling condenser, .0005-mf., C10;
  - One by-pass condenser, .002-mf., C11;
  - One regeneration control resistor, 0 to 1/2 meg., R1;
  - One sensitivity control, grid-leak 0 to 2 megs., R2;
  - Three 85 mh. R.F. chokes, RFC1, RFC2, RFC3;
  - Two type 24 tubes;
  - Two UY-type sockets;
- By connecting in series with condenser C3, at X, an X-I Variodensar, with a range of 0-.001-mf., more satisfactory tracking may be obtained in gauged tuning control.
- Radio frequency transformers L1, L2, L3, L4, are standard "antenna" coils; only two primaries are used, P1 and P4, as indicated. Tube V1 is the regeneration tube, and tube V2 is the signal frequency amplifier.

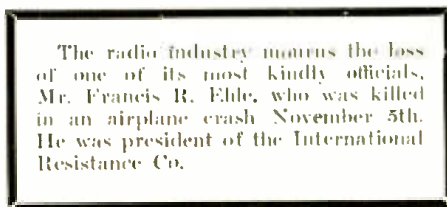

The radio industry mourns the loss of one of its most kindly officials, Mr. Francis R. Eble, who was killed in an airplane crash November 5th. He was president of the International Resistance Co.

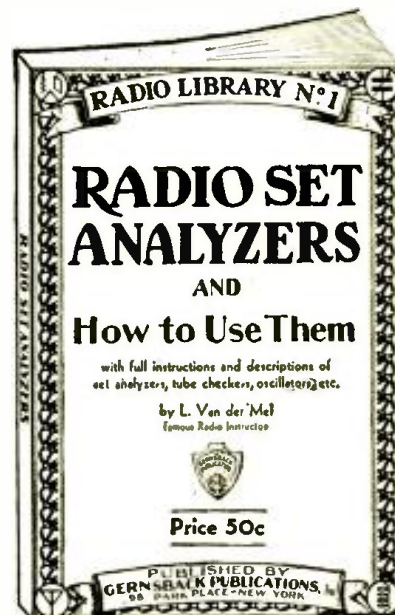

**50c The Copy**

**H**ERE is the latest book, and one of the most important which we have ever issued. It fills a long-recognized want for there is not a Service Man or a radiotician who has not an immediate use for this welcome book. It is the first book that explains COMPLETELY the operation of analyzers, tube checkers, oscillators, etc., from a thoroughly practical standpoint. The book is intended for Service Men of all classes, whether junior grade or expert. Everyone will find a tremendous amount of live "meat" in its pages. Nothing has been left to your own ingenuity; everything is complete.

- The contents:
- CHAPTER 1: Introduction; The Problems of the Service Man; General Description of Modern Receivers; The Need for a Radio Set Analyzer; What to Expect from an Analyzer.
  - CHAPTER 2: The Analyzer; The Fundamental Requirements of an Analyzer; The Switches or Push Buttons; The Ammeter; Multiscale Ammeters; The Shunt and Its Calibration; The D.C. Voltmeter; The Multi-scale D.C. Voltmeter; The Multiplier and Its Calibration; The A.C. Voltmeter; The Design of a Simple Analyzer.
  - CHAPTER 3: Trouble Shooting with the Analyzer; Classification of Trouble; (1) External to the receiver; (2) In the receiver proper; (a) Mechanical troubles; (b) Electrical troubles; Detailed Analysis of Electrical Trouble—(1) Tube Testing; (2) Localizing trouble; (a) By past experience; (b) By actual test of circuit; (3) Interpretation of analyzer readings; (4) Tube charts (use of); (5) Circuit diagrams (use of); (6) Testing the power unit; (7) The use of the analyzer in testing individual units; Additional Features and Uses of the Analyzer; (1) As a modulated R.F. oscillator; (2) As a means of finding up R.F. and I.F. amplifiers; (3) As an output meter; Care and Maintenance of Analyzers; Conclusion and Brief Summary.
  - CHAPTER 4: Detailed descriptions, photographs, and circuit diagrams of commercial set analyzers.

This book is sold at a ridiculously low price, because it is our aim to put this valuable work in the hands of 100,000 Service Men and Radioticians before the end of this year. Published by RADIO-CRAFT magazine, it has included in it all worth-while information available to the radio servicing profession; and for that reason the price of the book is kept at a very nominal figure. We know that, if you are at all interested in radio service work, you will send at once for this valuable book.

**Rush Coupon TODAY!**

GERNSBACK PUBLICATIONS, Inc., RC-132  
96-98 Park Place, New York, N. Y.

I enclose herewith fifty (50c) cents, for which send me a copy of your book "Radio Set Analyzers and How to Use Them."

Name .....

Address .....

City and State.....



# PUSH-PUSH AMPLIFICATION

(Continued from page 415)

plays the push-pull connection, as shown in Fig. 3. The operation of the circuit differs widely; however, from that of the push-pull circuit as the tubes are biased to cut-off of plate current and operate as a Class "B" amplifier.

The mode of operation is such, then, that each tube bears the burden of the power transfer during a single half of the signal cycle. During the first half of the cycle, the upper tube is being driven in the positive sense while the lower tube is entirely inoperative. During the next half-cycle, the lower tube is being driven in the positive direction while the plate current of the upper tube remains in a quiescent state. The result is an amplifier stage in which a given pair of tubes may be called upon to give an undistorted power output of from five to ten times that obtainable with the same pair of tubes in Class "A" operation with the same plate voltage!

The only changes demanded of the circuit are as follows: that the input transformer be of low ratio, since the grid winding must be of low effective impedance during the time that the individual tube is driven positive in order that the grid current flowing will not disturb the constants of the circuit; that the input grid swing or signal amplitude be several times that required for normal operation; that the output transformer be capable of handling the heavy D.C. pulsations resulting; that the power supply be capable of a high degree of regulation or constancy of voltage under varying loads; and that the grid bias be obtained in such a manner that it be not dependent for its value upon the plate current flowing through the tubes.

All these qualifications may be readily had with the equipment and apparatus available on the open market.

The necessary regulation may be obtained by the use of filter circuits of sufficient capacity, or through the use of the D.C. power lines for plate supply. The arrangement has a marked advantage for D.C. use, where the maximum potential available often does not exceed 100 volts. For public address or theater amplifiers, the regular 220-volt supply (as obtainable from D.C. power

circuits) is ideal, the resulting power being far in excess of that obtainable with A.C. supply and a given pair of tubes.

### Operation of Push-Push Circuits

In Fig. 4 are illustrated the characteristics of the two power tubes in "push-push" arrangement. The signal input is shown, as is the resulting output wave form. The slight distortion resulting from the fact that the amplitude of the input is such as to swing the alternate grids positive during a portion of each half-cycle, does not exceed the 5% deemed permissible.

The curves given are for type '10 tubes with the load in each plate circuit equivalent to 2000 ohms. For practical purposes, an output transformer devised for use with a pair of '50's should serve. It will be noted that a dotted line has been drawn in through the linear portions of the two characteristics; the point at which this line cuts the base line gives the optimum biasing potential, and the point at which the characteristic deviates markedly from the linear shows the maximum allowable grid swing. In this case, the grid bias will be seen to be -60 volts, and the maximum allowable grid swing about 120 volts (peak). This grid swing demand for power output up to the maximum limit makes it necessary that we employ a push-pull stage employing a pair of '27's (operated at their full plate voltage) prior to the push-push stage.

The power output from the system is given directly from the formula:

$$P = I_p^2 R_p$$

where  $I_p$  max. is the maximum plate current obtained during the positive peak of each half-cycle (in this case about 170 ma.), and  $R_p$  is the load resistance (2000 ohms). Thus in this instance of push-push operation there is obtained a power output of 29 watts, which may be compared with the power output obtainable with two '10's in the more standard push-pull connection, with the same plate voltage,—or about 5 watts!

### 110 Volts, D.C., as "B"

Similar multiplications of the output power available from a pair of standard

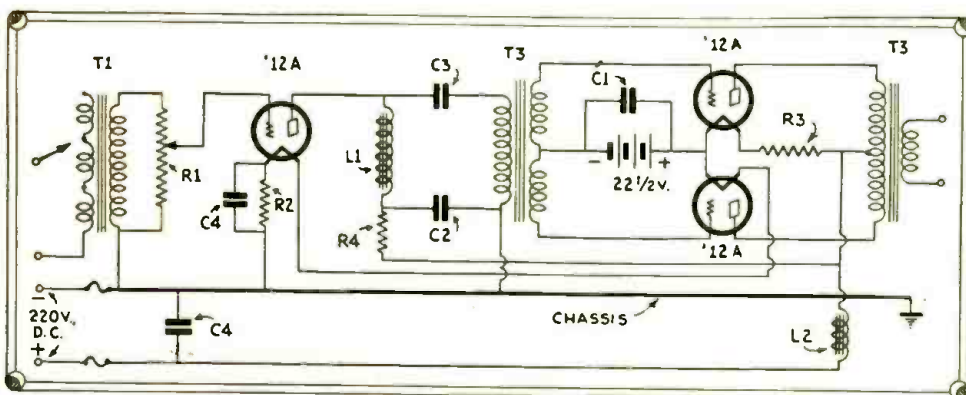

Fig. 5

Schematic circuit of a complete "push-push" audio amplifier which may be incorporated in any radio set operating on 110 volts D.C. Of course, the primary of transformer T1 must be designed to match the output circuit of the tube feeding the single '12A.

# YOU GET THERE!



## with RCA INSTITUTES radio training

**N**O matter what you want to learn in practical radio . . . whether you desire elementary or advanced knowledge . . . RCA Institutes is fully prepared to give you the training.

RCA Institutes . . . America's oldest radio training school, founded 22 years ago . . . is associated with the largest, most complete research laboratory in radio.

Large variety of courses. Enter the one fitted to your needs. Modern equipment. Instructors with practical experience. Four resident schools—New York, Chicago, Boston, Philadelphia. Enroll any time. Courses start every six weeks. Free university scholarships offered. Also extension courses for home study. Free resident school scholarships for outstanding graduates. Tuitions moderate.

As the oldest radio school in America—and the most modern, up-to-date courses—we have given training to nearly 20,000 men. Many of these now hold responsible positions in the radio industry. But none arrived overnight. Nor will you. Your success may depend upon how well you train yourself. But . . . be sure to get that training at the right place. Write today for our free catalog. The coupon makes it easy.



### A Radio Corporation of America Subsidiary

RCA Institutes, Inc., Dept. NP-1, 75 Varick Street, N. Y.  
Gentlemen: Please send me your General Catalog. I am checking below the phase of radio in which I am particularly interested.

- |  |   |
|--|---|
| <input type="checkbox"/> Aircraft Radio              | <input type="checkbox"/> Disc and Film Recording                |
| <input type="checkbox"/> Broadcast Station or Studio | <input type="checkbox"/> Servicing Home Entertainment Equipment |
| <input type="checkbox"/> Talking Pictures            |   |
| <input type="checkbox"/> Television                  |   |

Name \_\_\_\_\_  
Address \_\_\_\_\_  
Occupation \_\_\_\_\_ Age \_\_\_\_\_

*Make a PROFIT*

Servicemen make \$90 per month installing AMPERITE. Send \$1.62, to Dept. RC-1, for complete Sample and sales helps.

**AMPERITE Corporation**  
501 BROADWAY NEW YORK

**AMPERITE**  
Self-Adjusting  
LINE VOLTAGE CONTROL

# S. Gernsback's Radio Encyclopedia

Second Edition Contents  
Entirely New

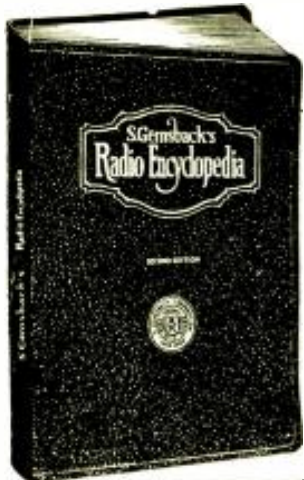

2,201 Radio Definitions  
1,253 Technical Illustrations  
34 Tables and Charts  
24 Pages of Appendix  
Size of Book:  
9 in. wide by 12 in. high  
**352 PAGES**  
Weight, 3 lbs.  
Red Morocco-Keratol Flexible  
Binding  
Printed on strong ledger paper  
Loose-Leaf Arrangement

**T**HIS book is the New 1931 Edition of the Famous First Radio Encyclopedia by S. Gernsback, the first book of its kind ever published in America. The new Second Edition—just off the press—is fully revised, rewritten, and enlarged. It is the absolutely up-to-the-minute new model of the pioneer First Radio Encyclopedia, which became the stand-by of all radio men in every part of the world. Over 30,000 copies of the first edition were sold.

### What the New Second Edition Radio Encyclopedia Gives You

It gives you an explanation of every word used in radio. These explanations—or, rather, definitions—are not brief outline information like those of an ordinary dictionary, but they give in fullest detail, and at considerable length, the meaning and application of every word, phrase, general and special term used in the science of radio. They are written in plain, everyday English, easily understood by anyone. Practically every definition in the book is illustrated by drawings, photographs, diagrams, or charts. All you need to do is to look up as you would in a dictionary, the word or phrase about which you are seeking information. Furthermore, each page is key-indexed, for greater convenience and speed in locating any definition. **All the Subject-Matter is Arranged in Alphabetical Order.** This greatly enlarged Second Edition Radio Encyclopedia is an absolute necessity to everyone interested in Radio. It answers all radio questions, increases your knowledge and saves your time. It covers every known radio problem, and is a goldmine of practical information for every radio man.

Mail Coupon Today!

S. GERNSBACK CORPORATION, RC-132  
98 Park Place, New York, N. Y.

Send me one copy of the new Second Edition S. Gernsback Radio Encyclopedia. I enclose herewith \$3.98, check or money order (preferred). (Foreign and Canada, add 35c extra for postage.) Money refunded in full if not satisfactory.

Name .....

Address .....

City..... State.....

vacuum tubes operated at low voltages are available for service from the D.C. supply—for example, from batteries, using the new "two-volt" tubes, etc. (Barton gives the ratings for the type '30 tube as a Class "B" amplifier.) The '30 is the general purpose tube—not the power output tube—of the battery-operated line, and its use offers a simplification in filament circuit design over the design methods necessary with the '31, which has a filament current of 130 ma. (as compared with 60 milliamperes for the '30). The simplification is most apparent where the tube is used in series-connected filament circuits, but also involves a saving of .140-ampere where parallel-wired filaments are used—as with the air-cell battery. The normal output of a '30 is 16 milliwatts, while with two such tubes in "push-push" an output of 1 watt is obtained—at a plate voltage of 157.5, and a negative bias of —16 volts.

The writer's original amplifier, prior to the publication of the Barton article, employed two '45's with a plate voltage of 100—as obtained from the D.C. power circuit. The grids were biased close to the cut-off of plate current.

The high current drain necessary for the operation of these tubes resulted in a tremendous light bill, nearly 200 watts being drawn from the supply circuit. The output transformers on the market were not of low enough impedance for the optimum conditions, but the power output obtained was fully equal to that with the same tubes at their maximum rating. The grids were swung directly from a screen-grid detector employing a '24 tube with a 1/4-meg. leak and a .0001-mf. grid condenser. Recently the system has been changed over to a pair of '12's, operating from the full 220 volts.

It was found, upon investigating the fact that a blown fuse sent the full 220 volts through half of the apartment, that the 220-volt line came right up into the kitchen instead of being split in the basement of the house. The receiver now draws a load of 50 watts with the filaments in series and puts a maximum undistorted power of about four watts into a dynamic reproducer working directly from a screen-grid detector into the power tube grids. This involves a maximum peak grid swing of 40 volts on the power tube grids.

Despite the change to the smaller tubes, the power output obtained is still equivalent to that obtainable from a pair of '45's working under optimum voltage conditions—but the power drain is only about an eighth that which would be required were the '45 filaments used and fed from the power line.

The circuit arrangement is shown here, Fig. 5, as adapted from the present receiver, but with provision made only for its operation as a phonograph or public address amplifier from the 220-volt lines. In almost all D.C. locations the 220-volt supply is available; either immediately at hand, or so close that it requires no great effort to tie in to it. The simplification of the amplifier as shown, over a job employing '45's, is rather obvious—the business of dropping the filament voltage along a resistance is of considerable difficulty when working with currents of the magnitude involved when the '45 is employed; and it is not likely that any job will be encountered where a greater

power output than is available from the unit shown in the figure will be demanded.

It must be repeated so that it will surely "sink in," that the output from the two '12's connected in "push-push" as shown in the diagram, is the equivalent of that of a pair of '45's operated in push-pull at the maximum allowable plate voltage. If necessary, the job shown can be made battery-operated with no sacrifice in power output although it will be necessary to cart around a small six-volt storage battery and a block of five 45-volt heavy-duty "B" batteries.

For the guidance of constructors, the following list of material used in the writer's amplifier is given:

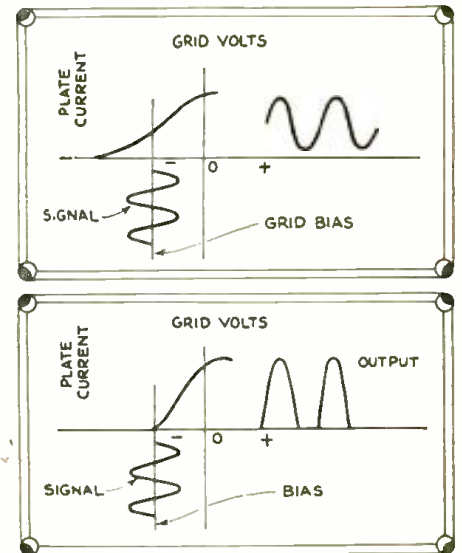

Fig. 1  
Above. Graph of push-pull operation.

Fig. 2  
Below. Push-push represented by graph.

### List of Parts

- One volume control potentiometer, 1/2-meg., R1;
- One bias resistor, 28 ohms, 2 watts, R2;
- One bias resistor, 630 ohms 10 watts, R3;
- One filter resistor, 5,000 ohms, 2 watts, R4;
- One Amertran input transformer, Type 406-A, T1;
- One Amertran push-pull input transformer, Type 151, T2;
- One Amertran push-pull output transformer, Type 143, T3;
- One Amertran coupling impedance, Type 103, L1;
- One Amertran filter choke, Type 557-A, L2;
- Two by-pass condensers, 2 mf. (each), 200 V., C1, C2;
- One coupling condenser, 1/4-mf., 200 V., C3;
- One electrolytic filter condenser, 32 mf., C1.

Two 50-watt tubes with 1000 volts on the plates can be called upon to deliver about 200 watts of undistorted audio power output; or a pair of '10's (as indicated in the curves) can be operated from one of the mercury vapor '80's at a plate voltage of 500 to give the same output power usually necessitating a pair of 50-watt tubes with a plate voltage of 1500.

The next radio season will in all probability see the use of this power output system in many radio receivers. The writer already knows of several manufacturers contemplating the use of the arrangement in commercial receivers for direct current operation.



# THE BOOSTER STAGE

(Continued from page 416)

of "B," and, by fine adjustment of C2, the oscillator and detector circuits can be made to track almost exactly.

The first I.F. coil L1 is an ordinary broadcast coil, either .00035-mf. or .0005-mf. type, tuned by C40. The regular primary is removed and replaced with 40 turns of No. 36 D.S.C. wire. If this coil is homemade, wind 10 to 40 extra turns on the secondary and use less of the tuning condenser; this gives slightly better selectivity and signal strength.

In arranging the parts, the detector tube should be at one end of the sub-panel, and the oscillator tube and coil at the other end, with the first intermediate tube and coil in the middle. The arrangement of the other components is not critical. The writer used a double-drum dial, which gave very smooth control of these selective circuits, although any equivalent dial or dials may be used.

The A.C. power supply unit used was salvaged from an old receiver; any pack delivering 2 1/2 volts for the filaments and 45, 90, and 180 volts of "B" may be used, or a 2 1/2-volt filament transformer and a standard "B" eliminator. In the writer's pack, it was necessary to add a 4-mf. condenser between the '80 and the first filter choke to eliminate A.C. hum.

### Results Obtained

A number of short-wave stations have been picked up on this booster. Presumably, the high frequency transmission was heterodyned by a harmonic of the oscillator's fundamental frequency. Station W2XAL has been received in California with very good volume. In the broadcast band, stations have been received on every one of

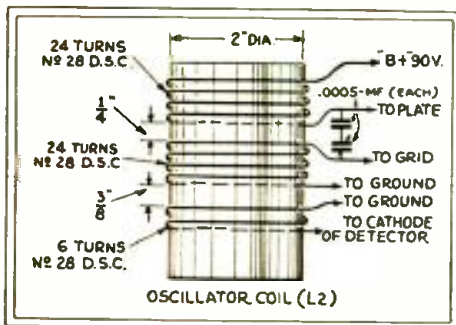

Fig. 2

Oscillator details. All coils are wound in the same direction.

the 96 channels, as well as a handful of Mexican stations in between the United States channels.

The writer uses a Model 91 Majestic receiver, but has operated the booster satisfactorily on a number of others.

When the booster is connected, turn the broadcast dial to about 540 kc. (just above the broadcast band), then turn the first I.F. condenser all the way in, and then back about one turn.

Tune in a local station and adjust condenser C4 for greatest volume, then find a weak station and make an exact adjust-

## TRUVOLT RESISTORS



**TIME**



**LABOR**



**EXPENSE**

Save Save

**F**EWER resistors required in stock—and fewer sizes in the serviceman's kit. That's the happy situation when you use TRUVOLTS. And see how easily repairs are made with TRUVOLTS—and the valuable time you save yourself and your customers.

The exclusive TRUVOLT Adjustable Clips may be added, removed or set any point for exact voltage values.

Patented, open-air winding keeps TRUVOLTS cool. All standard sizes.

### MAIL COUPON FOR CATALOG

175 Varick St., New York, N.Y.  
**ELECTRAD**

ELECTRAD, INC., 175 Varick Street, New York.  
 Please send me complete 36-page catalog and special replacement volume control guide.  
 Name \_\_\_\_\_ Address \_\_\_\_\_

RC-1

ment of this unit (which is very critical in its setting).

An aerial may easily be added to the booster, as indicated in dotted lines; switch SW. is the usual off-on type of instrument. In cases where extreme sensitivity and volume are desired without the directional properties of the loop, snap the aerial into the circuit,—but turn down the volume first, to spare the speaker.

If shielding is not used, hand-capacity effects will be eliminated by the use of Remler condensers; otherwise, the steel tuning shafts may be replaced with insulating shafts; and instead of fastening the condensers to the dial with the metal strips furnished, cut insulating strips the same size and use them to fasten the condensers from the dial).

### Dual Volume Control

Viewed from the front, Fig. B, the binding posts at the right go to the aerial and ground posts on the broadcast receiver; use shielded wire, with the shield making the ground circuit. The binding posts at the left are for the loop, while the single post at the rear-left is for the outside antenna. The knob at the left controls the A.C. line switch, and the one at the right, the Resistor-grad volume control (since the booster may be located several feet from the broadcast set, it would be inconvenient to operate its volume control).

No special care was taken with the wiring, except that "point-to-point" connections were made wherever possible. The cathode-oscillator pick-up coil lead is in shielded wire, as are several of the longer "B" leads, although this is not absolutely necessary (this shielding makes a convenient ground connection for some of the leads).

In one or two cases, it has been necessary to filter the "B" supply to the oscillator

(Continued on page 440)

FREE!

You cannot possibly afford to be without this valuable book. It is not just another catalog—it is indeed a VERITABLE ENCYCLOPEDIA of the RADIO INDUSTRY.

WHOLESALE PRICES TO ALL

JUST ISSUED!

Crammed full of Radio's latest innovations, quoted at prices to command your interest. Servicemen, Set Builders, Dealers, Agents . . . It will pay you to write at once for this vitally valuable catalog!



123 R West 17th St., New York N.Y.

## HEADQUARTERS

for all

### RADIO SERVICEMEN'S SUPPLIES

We carry the largest supply of replacement parts and general radio parts in the mid-west. Our store is the rendezvous for radio servicemen who will always find the latest and the best in radio merchandise in stock. We specialize in replacement transformers, condensers, resistors and volume controls for all makes of radio sets.

Be sure to drop in and see us when you are in Chicago.

## NEWARK ELECTRIC CO.

A Radio Service Institution

229 West Madison St. Chicago, Ill.

# FREE Miniature Edition

of Radio's Livest Magazine

SIMPLY FILL OUT AND MAIL COUPON!

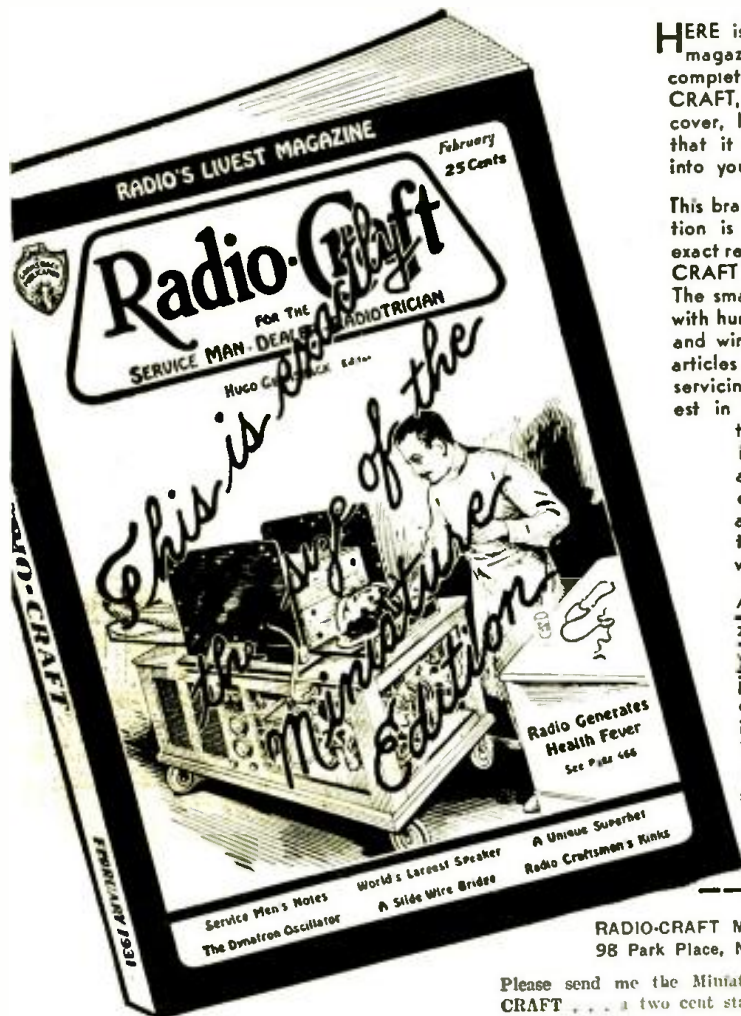

HERE is really a novelty in magazine publishing — a complete edition of RADIO-CRAFT, including a 4-color cover, has been reduced so that it can conveniently fit into your vest pocket.

This brand new miniature edition is in every respect an exact reproduction of RADIO-CRAFT in its usual dress. The small edition is complete with hundreds of photographs and wiring diagrams, lengthy articles by prominent authors, servicing problems and latest in radio. The type, although greatly reduced in size, is still readable, advertisements clearly distinguishable, and still the size of this copy is only 3/4" wide by 4 3/4" high.

A copy of this magazine will be sent to you absolutely FREE—just fill in the coupon completely and mail it to RADIO-CRAFT. Your copy of the miniature edition will be sent to you promptly by return mail.

RADIO-CRAFT Magazine RC-1  
98 Park Place, New York, N. Y.

Please send me the Miniature Edition of RADIO-CRAFT . . . a two cent stamp is enclosed to cover the cost of postage.

- I AM A RADIO DEALER
- I AM A SERVICE MAN
- I AM A RADIO ENGINEER
- I AM A RADIO EXPERIMENTER
- I AM .....

Name .....

Address .....

City ..... State .....

## CLASSIFIED ADVERTISEMENTS

### BUSINESS OPPORTUNITIES

**RADIO EXPERIMENTERS:** You can easily add to your present income by Locating Buried Treasure and Underground Metals through Radio Methods. We teach you how to build and operate. Full details for Red Stamp. Exchange, Box 607, El Monte, California.

### CHEMISTRY

**BECOME TRAINED CHEMIST.** Thousands of opportunities—fascinating career. Learn at home. Complete experimental laboratory outfit given. Write for big free book. Chemical Institute, 19 Park Place, Dept. RC, New York.

### INVENTORS

**PATENT YOUR INVENTION:** Send for FREE book, "How to Obtain a Patent," and "Record of Invention" blank. Consult us about how to protect your ideas. Victor I. Evans & Co., 620A Ninth Street, N. W., Washington, D. C.

### LATHES

**AN 8-INCH Back Geared Screw Cutting Lathe** for Radio Shop and Experimental Work, \$100 up. Easy Payment Terms. Cuts screw threads and machines metals of all kinds. Write for Circular No. 8 with illustrations, prices, and terms. South Bend Lathe Works, 148 Madison Street, South Bend, Ind.

### RADIO

**SERVICE MEN, ATTENTION**—Speakers re-wound, magnetized, repaired, \$2.00 to \$2.75. Complete Power Pack Service—Transformers re-wound, condenser blocks repaired, resistors duplicated. Guaranteed. Clark Brothers Radio Co., Albia, Iowa.

**TRANSFORMERS** (Radio Power) re-wound, special types made to order. Supreme Radio Laboratory, 16 Fulton Avenue, Rochester, N. Y.

## CRAFTSMAN'S PAGE

(Continued from page 420)

Kc.	Dial	Call	Station
1490	10	WCHJ	Chicago
1370	22	KUJ	Walla Walla
1190	38	WOAI	San Antonio
1050	50	KNX	Hollywood
910	59	WDAY	Fargo
900	63	KSEI	Pocatello
900	63	KHJ	Los Angeles
860	66	KMO	Tacoma
850	67	KWKH	Shreveport
800	71	WFAA	Dallas
780	73	XEW	Mexico City, Mexico
760	75	KVI	Tacoma
690	81	CFAC	Calgary, Alta., Canada
600	90	KFSD	San Diego
550	95	KFYR	Bismarck

## INFORMATION BUREAU

(Continued from page 422)

"The right-hand tuning knob controls a rotor coil for each stage, which through variometer action varies the inductance and thus tunes each zone. The contacts to these rotors should also be cleaned. The proper method of cleaning both zone and rotor contacts is to use a pipe cleaner or a special tool with special felt which has been dipped in "Carbena" or carbon-tetra-chloride; or, if the first two are not available, alcohol may be used. After the cleaning operation a very thin film of vaseline may be spread on the contacts to prevent future oxidation.

"We believe that this information will meet the requirements." (W. S. Hartford, Radio Sales Division.)

## THE BOOSTER STAGE

(Continued from page 439)

with a R.F. choke and 0.5-mf. condenser; so if the set does not work, try this the first thing,—it has never failed to cure. The writer has constructed a number of these instruments of a great variety of parts, and they have never failed to "perk," so no one should experience serious trouble with it.

I only hope that other experimenters may derive as much pleasure from the construction and operation of the Booster Stage as I have had and expect to have in the future.

### List of Parts

- One Lincoln collapsible loop, L;
- Two Pilot .0005-mf. variable condensers, C1, C2;
- Two X-L Variodensens, .0005-mf., C3, C4;
- Three by-pass condensers, 0.5-mf., C5, C6, C7;
- Two coupling condensers, .006-mf., C8, C9;
- One grid condenser, .00015-mf., C10;
- One by-pass condenser, 0.5-mf. (may not be needed), C11;
- Three UY sockets, V1, V2, V3;
- One Pilot drum dial;
- One I.F. transformer (described in text), I-1;
- One oscillator inductance (described in text), I-2;
- One bias resistor, 2,500 ohms, R1;
- One bias resistor, 4,000 ohms, R2;
- One Pilot volume control Resistograd, 0-1 meg., R3;
- One grid leak, 1 meg., R4;
- Two 85-mh. R.F. chokes, RFC1, RFC2;
- Two binding posts, BPI, BP2.



# AN ALL-WAVE SUPERHETERODYNE

(Continued from page 417)

loading the audio system when receiving local stations. The bakelite front panel measures 10 x 7½ in. high.

It is interesting to observe that Lincoln engineers have considered it unnecessary to shield the control-grid leads of the 24's. The wavelength range is covered in the following five jumps: 15-30 meters; 30-50; 50-100; 100-200; and the broadcast band, 200-550.

## The Power Unit

The power pack, a schematic circuit of which is shown in Fig. 2, is connected to the receiver chassis by means of a cable which is color-coded as indicated in the circuits.

Due to the careful design of the R.F. input system, it is possible to use an antenna length up to 100 feet where such pick-up is desirable and convenient; the normal length, however, is only about 15 feet. This pick-up is sufficient for excellent power output on even the most distant and weakest signals; in other words, if there is sufficient energy to actuate the first tube in this circuit, then there is sufficient amplification available to obtain loud-speaker operation.

To accommodate the output circuit to any type of reproducer, the output connections of the type 45 tubes terminate in tip jacks, as indicated in Fig. 1. This makes it quite convenient to use any type of dynamic reproducer, or even a magnetic unit. Of course, the output or matching transformer must be correctly designed for the input and output impedances.

An under-chassis view of this receiver would reveal the simplicity which has been obtained in the parts layout. Here we find the resistors, by-pass condensers, coupling condensers, R.F. choke, input A.F. trans-

formers, band-selector switch, trimmer condenser, off-on and volume-control resistor unit, low-high switch, and the radio-phonograph switch shown in the schematic circuit; the latter is mounted at the rear of the chassis, together with the output terminals. The chassis, which is of cadmium-plated steel, measures 21 x 10¼ in. deep.

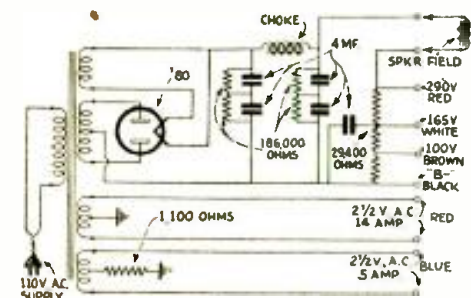

Fig. 2

Schematic circuit of the power pack of the Lincoln Model Deluxe SW-32 All Wave Receiver. Resistors shunt the 4 mf. electrolytic units.

former, band-selector switch, trimmer condenser, off-on and volume-control resistor unit, low-high switch, and the radio-phonograph switch shown in the schematic circuit; the latter is mounted at the rear of the chassis, together with the output terminals. The chassis, which is of cadmium-plated steel, measures 21 x 10¼ in. deep.

The signal-frequency inductances are wound on threaded bakelite tubes, which are contained in the large shield can immediately in back of the band-selector switch. There are five of these threaded tubes, the

## Repeat Points

Stations below 100 meters will create a high and low oscillator setting and thus will repeat on the dial. This is often an advantage as harmonics of short-wave code stations might interfere at one position of the tuning dial, for a given station, whereas they would not interfere at the second setting for this station. The recommended intermediate frequency to which this portion of the receiver should be adjusted is 480 kc.

It may be of interest to mention that a two-volt model, the D.C.-SW-10 Deluxe, has been developed for use where A.C. is not available. It includes a type 30 oscillator, second-detector, and first audio; type 32 first-detector and I.F. amplifiers; and type 31 tubes in the push-pull power output stage.

## CONTROLLED LIGHTNING

INVESTIGATIONS, conducted by the General Electric Co., (which will have an extremely important bearing on the broadcast reception which radio set owners will experience in the future) with particular regard to static discharges carried over the power lines and terminating in the receiver as clicks, and those interruptions of power service which are so annoying if they occur during an interesting broadcast and so devastating to the time-keeping quality of electric clocks, are being made on standard "low voltage" power lines at Wilkesville, N. Y.

A portable "lightning" generator delivering 1½ million, or more, volts is used in conjunction with a cathode ray oscillograph (or millionth-of-a-second camera). It is possible to give the output potential any desired wave-shape. Since the oscillograph must operate in microseconds, it is given a "starting bolt" of a few thousand volts a few microseconds before the big "jolt" to be recorded and analyzed, is put on the power line at a point four miles away.

Let us make the practical man happy by pointing out the advantages to be gained by research in this seemingly "abstract" field of lightning analysis.

Among many practical considerations may be mentioned the behavior of fuses under lightning voltages, protection of transformer banks, combinations of transformers with lightning arresters, and other effects of lightning on different equipment used in distribution systems.

## ANIMATED RADIO

PORTABILITY in a receiver has been obtained by the U. S. Army, which recently equipped a cavalryman with a receiver, and wound an aerial round a pole for him to carry. A rival, however, is reported from Morocco by *L'Antenne* of Paris; a radio enthusiast appeared at Catablanca with a camel who had a loop mounted above his head "like a saint's halo."

We have yet to hear the radio fish story.

# Make Depression Pay!

Take advantage of the present demand for repair of old receivers! Build strongly for the future, and increase your business by giving GUARANTEED REPAIRS.

You can do this safely by using Radio's Finest Parts—

# POLYMET PRODUCTS

Standard of the Industry

FOR FILTER BLOCK REPAIRS THE POLYMET KIT of 25 UNCASED CONDENSER SECTIONS illustrated below—is the most useful Kit ever assembled for service work. Many capacities and sizes, all in strict accordance with R.M.A. ratings.

Mail the Coupon for special low-price introductory offer. It will also bring you the new 1932 Polymet Parts Catalog, containing many service helps.



POLYMET MFG. CORP.  
834 East 134th St.  
New York City.

Send me your sensationally low-priced introductory offer on the Polymet Condenser Repair Kit. Also include the new 1932 Polymet Radio Parts Catalog, without charge.

Name .....  
Address .....  
City .....  
State .....

Mark Proper Square  
 JOBBER  DEALER  
 SERVICE MAN  CUSTOM SLP BUILDER

## Voltage Regulation

For receivers employing 110 volt transformers, use the CLAROSTAT AUTOMATIC LINE VOLTAGE REGULATOR which plugs in between the receiver cord and the wall outlet. Made in 5 sizes, from 50 to 250 watts. List Price .....\$1.75



For receivers with built-in protection (85 volt transformer) use the CLAROSTAT REPLACEMENT LINE BALLAST. A special model for every receiver. FREE CHART on request. List Price .....\$2.50

Clarostat Mfg. Co. Inc.  
285 N. 6th St.  
Brooklyn New York

• Index to Advertisers •

**A**

Amperite Corporation ..... 437  
 Arco Tube Company ..... 393

**B**

Blau the Radio Man, Inc. .... 424  
 Bretton Hall ..... 444

**C**

Cable Radio Tube Corp. .... Inside Front Cover  
 Carolina Crest Hotel ..... 444  
 Central Radio Laboratories ..... 429  
 Chemical Institute of N. Y. .... 432  
 Clarostat Mfg. Company ..... 441  
 Classified Section ..... 438  
 Coast-to-Coast Radio Corp. .... 439  
 Connie's Inn ..... 444  
 Coyne Electrical School ..... 387  
 Crosley Radio Corporation ..... 431

**D**

Delft Radio Company ..... 433  
 Drake Hotel ..... 444

**E**

Electrad, Inc. .... 439

**F**

Filtermatic Mfg. Co. .... 424

**G**

Gernsback Corp., S. .... 441  
 Gernsback Publications, Inc. .... 388, 430, 436  
 Grant Radio Laboratories ..... 433  
 Grempark Company ..... 446

**I**

International Resistance Co. .... 425

**J**

JMP Mfg. Company ..... 426

**L**

L & L Electric Company ..... 426  
 Lincoln Hotel ..... 444  
 Lincoln Radio Corp. .... Back Cover  
 Lynch Mfg. Company ..... 424

**M**

Midwest Radio Corporation ..... 448  
 Miles Mfg. Company ..... 424

**N**

National Radio Institute ..... 390, 391  
 National Radio Trade Directory ..... 434  
 Newark Electric Company ..... 439

**O**

Ozarka, Inc. .... 424, 433

**P**

Pilot Radio & Tube Company ..... 392  
 Polymet Mfg. Company ..... 441  
 Popular Book Corp. .... 436  
 Press Guild, Inc. .... 443

**R**

Radio Circular Company ..... 447  
 Radio College of Canada ..... 426  
 Radio Service Men's Guild, Inc. .... 433  
 Radio Trading Company ..... 445  
 Radio Trading Assoc. of America ..... 385  
 Radio Training Schools ..... 423  
 Radio & Television Institute ..... 394  
 RCA Institutes, Inc. .... 437  
 Radolek Company ..... 478  
 Readrite Meter Works ..... 435

**S**

Scott Radio Labs., E. II. .... 389  
 Silver-Marshall, Inc. .... 421  
 Supreme Instruments Corp. .... 427

**U**

Universal Microphone Co. .... 428

SERVICE-SELLING SUPERS

(Continued from page 420)

In general it may be said that the whole servicing problem of the short-wave portion of the short and broadcast band receiver involves nothing more than first ascertaining that the broadcast band portion of the receiver is functioning properly, making careful continuity, condenser, and tube tests on the short-wave portion of the circuit, and finally a careful ear test. In a word, servicing of short-wave receivers or the short-wave portion of combination receivers is appreciably more simple than that of servicing a good broadcast-band superheterodyne.

For the benefit of Service Men, the following operating characteristics, when the volume control is set at maximum, are given: Filament potentials: V1, 2.2 volts; V2, V3, 2.25 volts; V6, 2.3 volts; V4, V5, V7, V8, 2.35 volts; V9, V10, 2.4 volts; V11, 5.1 volts. Plate potentials: V1, V3, V4, V6, V7, 216 volts; V2, 80 volts; V5, 75 volts; V8, 178 volts; V9, 224 volts; V10, 220 volts. Screen potentials: V1, V3, V4, V6, V7, 96 volts; V9, V10, 240 volts. Control-grid potentials: V1, 18 volts; V2, 0.0 volts; V3, V6, V7, 3 volts; V5, 1.1 volts; V8, 20 volts; V4, V9, V10, 16 volts. Plate currents: V1, 0.08-ma.; V2, 8 ma.; V3, V6, V7, 6 ma.; V4, V8, 0.1-ma.; V5, 10 ma.; V9, V10, 32 ma.

Parts List

The component parts of this receiver have the following values: Condensers C1, C2, C3, tuning units, 407 mmf. max. capacity;

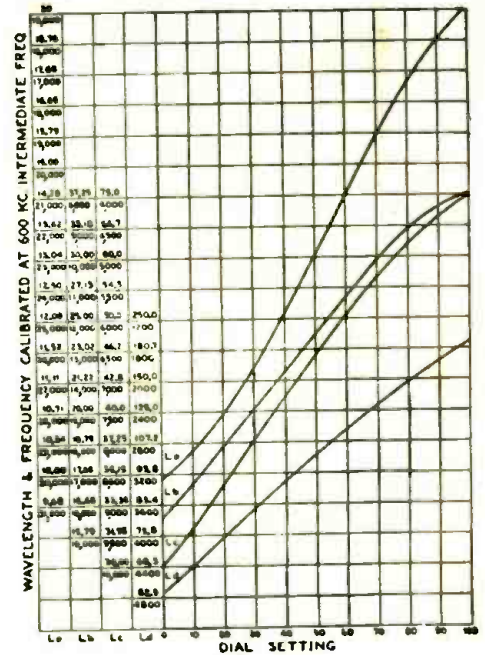

Fig. 3

Tuning graph of a particular short-wave set.

C4, 250-600 mmf. (variable); C5, 750 mmf.; C6, C7, C8, C15, C18, C19, 0.1-mf.; C9, 0.5, 0.5, 1, mf.; C10, C26, 0.001-mf.; C11, 0.15-mf.; C12, 0.25-mf.; C14, three 4-mf. (dry electrolytic, Potter); C16, C17, C24, C25, C27, C28, 0.006-mf.; C20, C21, 140 mmf. (two-gang variable); C22, 80 mmf., C23, comp.

Resistor R1, 30,000 ohms (1 watt); R2, 0.5-megohm (tapered variable resistor); R3, R9, R14, 60,000 ohms (1 watt); R4, R10, 100 ohms (wire wound); 4,500 ohms (volume control, tapered); R6, 13,500 ohms (1 watt); R7, 15,000 ohms (2 watts); R8, 400 ohms (wire wound); R11, R13, R16, R17, 10,000 ohms (1, 2, 2, 1 watts, respectively); R12, 220 ohms (2 watts); R15, 6,500 ohms (1 watt).

Coil L1, 167-S; L2, 168-S; L3, 175-S; L4, 281 (R. F. Choke); L5, 10145 (Choke); L6, 277 (R. F. Choke); La, S.W. coil 10-20 meters; Lb, S.W. coil 20-40 meters; Lc, S.W. coil 40-80 meters; Ld, S.W. coil 80-200 meters.

Transformer I.F.T.1, type B-1; I.F.T.2, type B-2; I.F.H.3, type B-3; A.F.T.1, type A-270; A.F.T.2, type 10143; P. T., type 10173-S.

IS THE "COLD" TUBE HERE?

RECENT publicity releases state that the filamentless, cold-cathode tube of Dr. August Hund, noted engineer, is ready for demonstration by Wired Radio, Inc. If this device is not restricted to the requirements of wired radio service, it is possible that the instrument may become available to radio set owners. It is not known at the present writing whether the new tube offers any other advantages than perhaps long life and low upkeep cost. In appearance, the tube is said to resemble a fountain pen.

Call Letter	Wave Length	Frequency	Location	Time schedule in Eastern Standard Time
WJZK	17.34	17,300	Schenectady, New York	Tues., Thursday, Saturday-12 p.m. to 5 p.m.
WJZKAD	19.56	15,340	Schenectady, New York	Relays WJZ, Daily 8:00 a.m. to 10 a.m. also 1:30 p.m.
WJZK	19.72	15,210	Pittsburg, Penna.	Relays KDKA, Tues., Thurs., Sat. and Sun. 6 a.m. to 12:00 noon
KDA	20.00	14,680	Mexico City	Daily 8:30 p.m. to 3:00 p.m.
WJZK	22.35	13,420	Schenectady, New York	Mon. 9 p.m. to 3 a.m. Tues.-Thurs., Sat. Noon to 3 a.m.
WJZK	25.84	11,600	Pittsburg, Penna.	Relays KDKA, Tues., Thurs., Sat., Sun. 12 noon to 5 p.m.
KJCR	25.86	11,580	Manila, P.I.	Daily except Mon. 8 to 6 p.m. 2 to 4 p.m.
OSW	25.58	11,750	Chelmsford, England	Daily except Sat. and Sun. 7:30 to 8:30 a.m. 2 p.m. to 7 p.m.
FLSKE	28.00	10,710	Sydney, Aus.	Irregular Wednesdays after 6 a.m.
PCJ	31.58	9,500	Eindhoven, Holland	Wed. 5 p.m. to 9 p.m.; Thurs. 1 p.m. to 3 p.m. 8 to 12 p.m. Fri. 7 p.m. to 9 p.m. and 8 p.m. to 2 a.m.
WJZK	31.55	9,570	Springfield, Mass.	Relays WJZ-A daily 7:30 a.m. to 11 p.m.
SLAA	36.00	8,300	Leningrad, Russia	Monday, Tues., Thurs., Fri. 2 to 6 p.m.
WJZK	44.60	6,720	Georgetown, British Columbia	Wed. and Sunday 7:15 p.m. to 10:15 pm
WJZK	46.08	6,510	Pittsburg, Penna.	Relays KDKA Tues., Thurs., Sat., Sun. 5 pm to 12:00
PL	48.99	6,120	Biffal Tower, Paris	Daily 8:45 am to 12:30 pm. 4:15 pm to 4:45 pm
WJZKAL	49.18	6,100	Bound Brook, New Jersey	Relays WJZ daily except Sunday 6 pm to 7 pm, 11 pm to 2 a.m.
WJZKAA	49.34	6,090	Chicago, Ill.	Relays WJZ daily except Sunday 6 am to 7 am. 7 pm to 8 pm. 9:30 pm to 10:15 pm. 11 pm to 12 pm.
WJZK	49.40	6,070	Vienna, Austria	Tues. and Sat. 5 to 7 am 8 5 to 7 pm. Thursday 9 to 12 am.
WJZKAL	49.50	6,060	Cincinnati, Ohio	Relays WJZ daily 6:30 am to 11 am 1:30 pm to 3 pm. 6 pm to 1 am.
WJZK	49.68	6,060	Chicago, Ill.	Relays WJZ daily 10:15 am to 1:45 am 5:30 pm to 7 pm. 8:30 pm to 12:30 pm. 3:30 pm-6 pm 8 pm-1 am.

Fig. 2 Domestic and foreign short-wave stations.

(While every precaution is taken to insure accuracy, we cannot guarantee against the possibility of an occasional change or omission in the preparation of this index.)



# BOOK REVIEW



"Talking" scales, states a Department of Commerce report, have been introduced in England. Sound records will do the trick; but watch out for "double tracking," under trying conditions, such as illustrated above.

### HOME-TALKIES FILM LIBRARIES

THE first of 150 film exchanges has been opened with great ceremony in New York City by Talkies, Incorporated. These exchanges, which will be opened throughout the country, will make available on a rental basis a large library of films and accompanying sound records. Each exchange maintains a service department for the repair of films.

**REVIEW OF AUDIO AMPLIFIERS**, by J. C. Aceves and G. C. Cron. Published by International Textbook Co., Scranton, Pa. 5 x 7½ inches, 170 pages, cloth; 93 illustrations.

This book is excellently written for the college student who is possibly studying Electrical Engineering and taking a course in radio theory.

Details on the design of audio transformers and filter chokes are worked out so that if the student were studying transformer design, then this book would prove quite valuable.

Different types of commercial amplifiers are described but the book is sadly lacking in recent developments such as the tuned filter choke system and the direct coupled amplifier.

The methods of connecting loud-speakers and headsets for program service in large hotels and hospitals are also described and though these methods could be used, they are not, to any extent, used in practice.

The book is divided into three sections, the first being devoted entirely to ordinary radio theory and comprises about one third of the text. This section is written by J. C. Aceves, while the remainder is written by G. C. Cron, who is a very well known transformer engineer.

There are few technical errors and the book should make interesting and easy reading for anyone who has a little electrical knowledge. However, it is not recommended for radio Service Men as it is entirely too general in scope to be of much aid to these individuals. As a library addition or reference guide, it is ideal, for it covers the field of audio amplifiers very well.—E. M. L.

**REVIEW ON RADIO TRANSMITTERS**, by H. F. Dart and E. V. Amy. Published by International Textbook Co.,

Scranton, Pa. 5 x 7½ inches, 164 pages, cloth; 69 illustrations.

The first section of this book is written by H. F. Dart and illustrates and describes methods of learning to read and send code. The remainder of the book is written by E. V. Amy and is a comprehensive discussion on radio, telegraph, and telephone transmitters.

The text is very complete and describes almost every type of radio transmitter, both commercial and otherwise. Formulae for determining the dimensions of the Hertzian antenna are given and these, if worked out for a definite wavelength, check very well with actual known values.

The action of vacuum tube oscillators is described, also the transatlantic telephone transmitter at Rocky Point. However, recent developments on breaking up the transmitted telephone conversation, so as to make it quite impossible to understand by listeners-in, were devised and put into effect at this transmitter some time ago. The description of this feature is lacking from the book, due evidently to the fact that the book went to press before the transmitter was equipped for the above action.

The book is extremely general in its nature and is recommended for those who are intending to take government examinations for operating licenses, as the transmitter data, circuits, and information should prove invaluable, both to commercial and broadcast operators.

Some of the more important of the many complete transmitter circuits included in this edition are:

- Model ET-3628 ACCW;
- Model ET-3655 Short-wave Transmitter;
- One Kilowatt Broadcast Transmitter;
- Five Kilowatt Broadcast Transmitter (Western Electric);
- Ten-watt Aircraft Transmitter;
- Data on Tube Layout for Composite Broadcast Stations.—E. M. L.

## THREE NEW 50c BOOKS

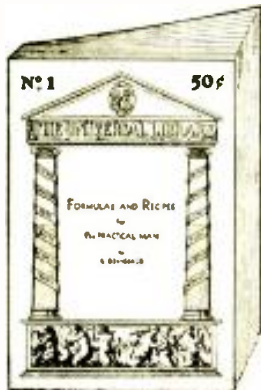

FORMULAS AND RECIPES For the PRACTICAL MAN

### CONTENTS

1. Adhesives: Glues, Cements, Gums, Mixtures, Lubricants
2. Cleaning: Stain Removers, Bleaches, Cleaning Fluids
3. Metal Craft: Coloring, Oxidizing, Plating, Repairing, Welding, Polishes, Alloys, Solders—Paints; Colors, Stains, Varnishes, Emulsions, Luminous Paint, Washable Paint, Paint-Removing, Waterproofing, Fireproofing—
4. Glass-Working: Cutting, Drilling, Boring, Bending, Blowing, Etching, Engraving, Frosting, Silvering, etc.—
5. Wood-Craft: Fillers, Fireproofing, Acid-proofing, Waterproofing, Furniture Polishes—
6. Inks; Eradicators, Ink Stain Removers; Sympathetic, Invisible, Hectograph—
7. Photography: Developers, Emulsions, Fixers, Sensitizing, Toning, Printing, Photographic Paper, Blueprint Paper—
8. Antitodes for Poisons, Remedies for Burns and Scalds, Disinfectants, First-Aid in Accidents, Home Remedies—
9. Preparation, Manipulation, Handling, Mixing, Emulsifying; Use of Hydrometer, Use of Thermometer; Tables of Weights and Measures, Decimal System, Useful Tables.

FROM the table of contents, it will be seen that the book contains only such material as is constantly needed and can be practically applied by the man who is doing or making things.

Every formula has been selected with a view to its usefulness to the experimenter and practical technical man.

Not only that—This book is intended to serve directly for the use of the man who wishes to work out desirable preparations for practical home manufacture, as a means to earning spare-time money.

It is well known, in the case of innumerable preparations that have become household standbys and whose production now runs into millions of dollars of profit—and if the truth were known, this would be found to be the origin of nearly all such successful enterprises—that the biggest manufacturers, who have built up tremendous factories making all these things which you use in your own home, shop, and business, started on the road to success with just such a small beginning as you, perhaps have been dreaming about.

This book will be useful also in helping you to save money by showing you how to make in your own home at a fraction of their usual cost the hundred and one preparations which you now buy ready-made for use in your home or business.

This book has been compiled by S. Gernsback, a well-known author of practical instructional manuals in various scientific fields; you will find it a real help and an instrument for self advancement. It will serve you as a money-saver and a money-maker!



FUNDAMENTAL PRINCIPLES OF RADIO Radio Simply Explained—Its Origin, Nature and Functions

### CONTENTS

- Chapter I—Fundamentals of Radio: Electricity, Resistance, Batteries, The Magnetic Circuit, The Magnetric Field, Inductance, Transformers, A.C. Circuits, Propagation of Radio Waves; Chapter II—The Simple Radio Set, Single, Two, and Three - Circuit Tuners, The Battery Set, Vacuum Tubes, Electric Sets, Loud Speakers; Chapter III—Diagrams, How to Read Them; Chapter IV—Amateur and Broadcast Stations, Talking Pictures, Television.

THIS BOOK is intended as a handy fundamental aid for "checking up" and systematizing your knowledge of radio, no matter what stage of the art you have thus far mastered by study or experience.

It is intended for those who may have had to get their first working knowledge of radio through experience in a haphazard fashion and now want to get a more solid grounding in its principles and theory.

It is intended for the practical man, the technician who wants to get a practical comprehensive knowledge of the principles underlying the HOW and WHY of Radio.

The book has been prepared with special consideration for the young members of the profession; and one of the main objects has been to state in plain English the few important elementary principles which the authors of most books on radio envelop in such a haze of technical mystery as to keep their explanations beyond the understanding of the ordinary man.

There is no more mystery about radio in the mind of the reader after he has read this book!

The author, being a former instructor in radio, knows how to go about explaining in simple language, the origin and nature of radio; he leads his reader through clear description and practical analogies, step by step, until he understands the working of the most complicated circuit.

You will find in Mr. Martin's book a really intelligible discussion of a lot of subjects in radio, for which you have never before been able to find an elementary explanation in such easy-to-grasp and understandable terms.

Even if you think that you know a very great deal about radio, you should get this book, even if only to see in what a charmingly easy way Mr. Martin has dealt with a difficult and abstract subject.

THIS MANUAL has been written especially for the man who wishes to acquire a working knowledge of the elementary principles of mathematics for his own every-day use. To provide a complete treatment, the author starts from the beginning of the subject, explaining the first principles of arithmetic in simple, clearly understandable language, and from these, takes the reader by easy steps through all the rules and processes of arithmetical calculation.

A good technician is not always a good mathematician, but the art of computation by figures is easy to acquire. If you are guided by some one who knows how to direct your way and make it easy.

That is the object of this book. Mr. Shalmark, who is an instructor in practical sciences, knows how to explain things in plain English, and his one purpose in this book is to make clear, in terms of daily application, the important basic principles of mathematics which everyone ought to know, whether he be a working man, a merchant, or a professional man.

Special attention is devoted in this book to showing the man who is employed in industry or in technical work, how to apply the working rules of mathematics in his profession or business.

All our books are of uniform size 6x9 in. containing 61 pages printed on strong paper with stiff colored covers.

**PRESS GUILD INC., 16 Murray St., New York City. ItC-1**

Enclosed find \$..... for which mail me postpaid the following books:

No. 1 }  
 No. 2 } 50c each, Postpaid, all three for \$1.25.  
 No. 3 }

Name .....

Address .....

City and State.....

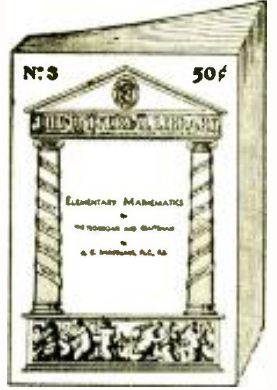

ELEMENTARY MATHEMATICS For the Technician and Craftsman

### CONTENTS

- I—Arithmetic: Addition, Multiplication, Subtraction, Division, How to Use Decimals; II—Fractions, Percentages, Ratio and Proportions; III Powers and Roots; IV—The Metric System; V—How to Measure Surfaces and Volumes; VI—Mathematics for the Manual and Technical Craftsman; VII—Special Mathematics for the Radio Technician; VIII—Commercial Calculations, Short-cut Arithmetic, Interest Calculation, Discounts; IX—Weights and Measures; X—Useful Tables.

## HOTEL DIRECTORY OF THE RADIO TRADE

The Hotels on this page are Patronized by the Radio Trade. Make them your Headquarters

### One in a Thousand



At 999 hotels in Atlantic City you can get the same thing . . . rooms with or without meals . . .

\*An Original and Unique Service has made

### THE CAROLINA CREST

The Thousandth Hotel

\*Abed or at your service table enjoy a delicious Tray Breakfast WITHOUT CHARGE—in the privacy of your own comfortable room while you glance through your morning paper . . . then wonder—as all our guests do—how we happened to move your home to the

### CAROLINA CREST

North Carolina Ave., near Boardwalk  
ATLANTIC CITY, N. J.

SPECIAL WINTER RATE

\$3.00 per day

Every room with private bath—  
Bed lamps and at least three windows.

H. L. FAIRBAIRN, Mgr.

*"The Gathering Place  
of  
Cosmopolitan New Yorkers."*

The RUSSIAN VILLAGE  
100 West 57th Street  
New York City

Dining, Dancing, Russian and Gypsy  
Entertainment.

LUNCH — TEA — DINNER

No cover charge at any time.

Broadcasting WOR Circle 7-9434

### The Home Hotel of New York

Homelike in service, appointments and location . . . away from noise and congestion, yet but a few minutes from Times Square . . . garage facilities for tourists.

Room and Bath from  
\$3 single \$4 double  
500 Rooms

Home folks will  
like this hotel

HOTEL

**BRETTON HALL**  
BROADWAY at 86th ST.  
NEW YORK



A riotously gay new revue at  
Connie's Inn featuring the  
finest in colored entertain-  
ment! Dance-compelling  
music by Fletcher Hender-  
son and his orchestra.

### CONNIE'S INN

131st St.—7th Ave., N. Y. C.  
Tel. Tillinghast 5-6630

A SPECIAL OFFER TO NEW READERS  
— Eight months subscription to RADIO-CRAFT  
for \$1.00. Send remittance to RADIO-CRAFT,  
98 Park Place, New York, N. Y

**The Crossroads of a Nation**  
THE DRAKE is admittedly one of the great hotels of the world . . . the stopping place of seasoned travelers. Rooms are spacious and smartly elegant . . . continental in atmosphere. Available, also, is an experienced Travel Bureau . . . to relieve you of every travel detail. Rates begin at \$4 per day. Permanent Suites at Special Discount

**THE DRAKE HOTEL, CHICAGO**  
Under Blackstone Management

AN ADDRESS OF DISTINCTION

**THE NEW HOTEL LINCOLN**  
EIGHTH AV.—44<sup>th</sup> 45<sup>th</sup> STS.  
Just a Step from B'way  
NEW YORK CITY

The New and Beautiful  
HOTEL LINCOLN  
You are assured of MAXIMUM COMFORT and MAXIMUM SERVICE

1400 Rooms, each with tub and shower—Servidor

SINGLE:  
\$3.00, \$3.50, \$4.00, \$5.00  
DOUBLE:  
\$4.00, \$5.00, \$6.00, \$7.00

RADIO—DeForest Direct—now being installed in every guest room

**ROY MOULTON**  
MANAGER



# FREE!

# JUST OUT

Nothing  
Like it  
in Print

100  
Hook-  
ups

675  
Illus.

76  
Pages

YOU  
MUST  
HAVE  
THIS  
GREAT  
BOOK

ACTUAL  
SIZE

8x9 1/2"

THE new Winter edition of our RADIO SERVICE TREATISE, twice as large as our former one, has just come off the press. It is positively the greatest book in print—NOT JUST A CATALOG. It contains a large editorial section—a veritable book in itself with more valuable information not found anywhere else. Among the

# RADIO SERVICE TREATISE

AND  
RADIO BARGAIN CATALOG  
FOR RADIO SERVICEMEN-  
RADIOTRICIANS-RADIO DEALERS

**RADIO TRADING CO.**  
WEST BROADWAY  
NEW YORK CITY

WINTER  
1932

CATALOG  
No 24

COPYRIGHT 1931 BY R. T. CO.

wealth of new technical information listed in the editorial section are the following: 1932 Complete Radiotron Characteristic Charts.—Versatile Power Amplifier for use with Short-Wave Tuners and Phono-Pickups.—Constructional Data of Servicemen's Test Oscillator using latest A.C.-D.C. Dynatron Circuit.—All About Tone Controls.—Short-Wave Adapters and Converters.—Constructing a 3-tube Super-Het Converter.—Modernizing Old Radio Sets.—How to Select and

Install Replacement Parts in Standard Radio Sets. How to Choose Power Transformers.—Bringing Your Set Up To Date with latest type Multi-mu and Pentode tubes.—All About D.C. Receivers. Vacuum Tube Treatise.—How to Take Care of your Tubes—And dozens of new radio experiments, hints to Servicemen, valuable tables on useful radio data, etc., etc.

This book is not just another catalog but a veritable mint of radio information which will be of infinite and everlasting value to you.

WRITE TODAY. Enclose 2c for postage. Book sent by return mail.

## RADIO TRADING CO.

23 WEST BROADWAY

NEW YORK

**OXFORD DYNAMIC CHASSIS**

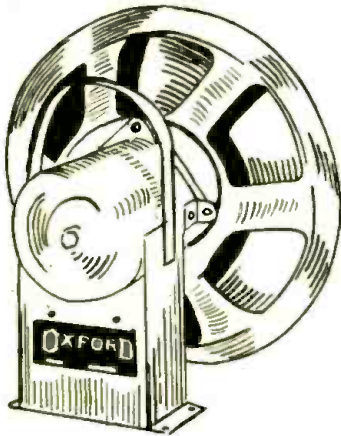

These speakers are noted for tone without hum. D. C. models can be supplied with push-pull output transformers. A. C. Models with 280 tube as rectifier.

14" Audit ..... \$12.95  
 12" Concert Dynamic 8.95  
 9" midget A. C. Dynamic ..... 7.50  
 D.C. and A.C. Field Chassis

14" 5000 ohm field.... \$7.95  
 11 1/2" 2500 ohm field.. 4.95  
 Midget 1000 ohm field 3.49  
 Midget 2500 ohm field 3.49  
 Midget 2500 ohm is supplied with hum balancer.

**JENSEN DYNAMIC CHASSIS**

Jensen Dynamics are used by leading manufacturers in their sets. We can supply most of their models.

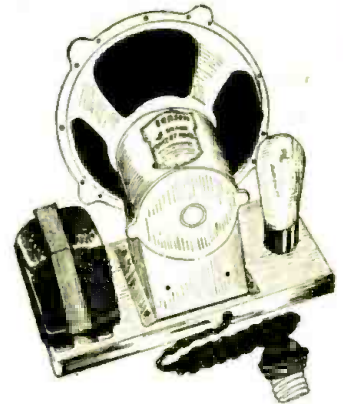

**A. C. MODELS**

D8 A. C. rectifier.. \$14.95  
 Jr. Audit. tube as rectifier Midget using 280 tube ..... 12.95

**D. C. MODELS**

D7 2500 ohm field 12" \$8.95  
 D7 1000 ohm field 12" 8.95  
 Midget 2250 ohm field 5.95

**PENTODE ADAPTER**

This Pentode Adapter permits the insertion of a type 247 Pentode Power Tube in place of the type 245 tube. Simply remove 245 tube, and insert the Adapter, and plug in the 247.

**OUR NET PRICE**

**\$1.20**



**A-B-C POWER PACKS**

There are now available to the Service Man, experimenter, and custom set builder three models of power packs designed to supply "A," "B," and "C" potentials to radio receiver chassis of almost any type. Each pack is complete with voltage divider, filter condensers, filter choke, by-pass condensers, and taps for intermediate voltages (R.F., Detector, A.F., etc.) Two leads are provided for connection to a dynamic reproducer field; or the circuit may be completed through a filter choke supplied with each instrument, where the reproducer is a magnetic, or self-powered dynamic unit.

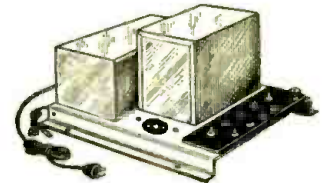

Pentode, screen-grid, variable-mu, and all the other tubes may be powered from one of these packs. The characteristics of each are as follows:  
**Type A.** Filament supply for four type '26 tubes, one '27, two '71A's, and an '80. Plate Potential, 180 volts; and the "C" voltage requisite for type '71A tubes.  
**Type B.** Filament supply for four type '24 or '27 tubes, two '45's and an '80. Plate potential, 180; and "C" for the '45's.  
**Type C.** Filament supply for four type '24 or '27 tubes, two '47 pentodes, and an '80 rectifier. Plate potential, 250 volts; and "C" for the '47's.

Each of these units is provided with taps supplying the usual R.F., detector, and A.F. voltages. These A.B.C. Power Units are going like hot-cakes

**OUR PRICE FOR ANY TYPE**

**\$6.75**

**MAGNETIC CHASSIS IN BOSCH CABINETS**



Due to the many battery operated sets still in use which require magnetic speakers, we offer the following in the beautiful Bosch cabinet.

**Bosch Chassis**

B. B. L. Chassis..... \$4.95  
 Utah Chassis ..... 4.95  
 R. C. A. Chassis..... 4.95  
 Farrand Chassis ..... 4.50

**FARRAND Inductor Dynamic**

One of the best sounding speakers you ever heard. Words cannot describe the tone of this speaker. No danger of hum, noise of electricity and yet is superior to many dynamic speakers. Two models. 9", \$6.95; 12", \$7.95.



**POWERTONE Microphone Stands**

Powertone Elec. Co. has now entered the microphone field with a complete line of microphone stands. We are in a position to supply any type of stand. The above stand is 12" high.

Your Price ..... \$3.50

**R.C.A. MODEL CHASSIS**

Famous R.C.A. chassis in models for every set.

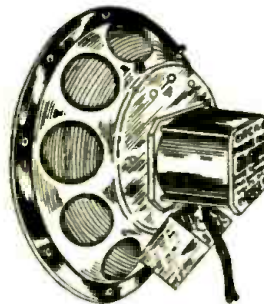

A. C. Model 106 with 280 tube.. \$12.50  
 D. C. Model, 330 volt field, 1000 ohm, with output trans..... 5.50  
 Same as above less transformer.. 4.50  
 Model 106 12" 2500 ohm field.. 7.50

**BALDWIN DYNAMIC CHASSIS**

Made by the famous Nathaniel Baldwin  
 9" A.C. with 280 tube \$7.50  
 9" D.C. 2000 ohm & sta 5.50  
 9" D.C. 2000 ohm without stand 4.00  
 9" D.C. 2000 ohm less output trans. 3.25  
 This speaker is noted for its fidelity of tone and sensitivity.

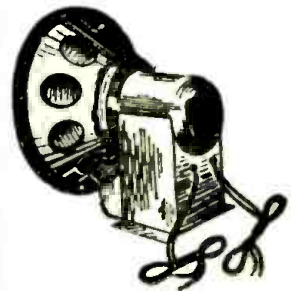

**B.B.L. SCRATCH FILTER**



It is now possible to filter out scratch produced by the needle as it rides over the grooves with the B.B.L. scratch filter.  
 Price ..... 35c

All offers are F.O.B. New York, and subject to prior sale. Terms: A deposit of 20% is required with every order. Balance may be paid on delivery. Or, deduct 2% if full amount is sent with order.

**DO NOT WRITE FOR CATALOG!**

**GRENPARK CO., Dept. RC. 245 Greenwich Street, New York, N.Y.**



# \$

# Prices YOU can make a REAL profit on!

# \$

### Famous Model "G" Gordon Phono-Motor and Turntable

First time at this price. Ruggedly constructed throughout. Spanish felt gears assure silence. Equipped with automatic stop control. Induction type, no brushes. Easy to install—exceptionally quick starting torque. For 110 volt 60 cycle alternating current. Proven dependability has made this New Gordon Electric Phonograph Motor and Turntable the accepted standard of excellence for the industry.

First time at this price. Make a nice profit and build good will with everyone.



List \$30.00  
**OUR PRICE \$8.95**

### Farrand Dynamic Chassis

Famed for its simplicity and reliability. Easily installed in all types of radio or phonograph consoles. Tonal range and fidelity superior to any other reproducing unit in general use. Dimension: Height 9 inches, width 8 3/4 inches, depth 7 inches. For A.C. current.



**OUR PRICE \$5.95**

### Condenser Block for Majestic "B" Eliminator



**OUR PRICE \$2.75**

Replacement for defective blocks in "B" Eliminators—identical in electrical characteristics and outside dimensions. Can also be used in any make "B" Eliminator as well as most power packs.

### Gordon Acme 4 Pick-Up with Volume Control

Genuine Bakelite arm with beautiful natural wood finish will not show wear as will plated metal. Faithfully reproduces the entire musical range.



**OUR PRICE \$4.50**

**I.C.A. Test Leads**—a necessity to the dealer or serviceman. Unsurpassed for testing sets and tracing shorts, opens and other common defects. Easily attached to testing meter or electrical apparatus. **40c**

### Fixed Pigtail Resistors

OHMS		
500	10,000	75,000
1,000	15,000	100,000
1,500	20,000	125,000
1,800	25,000	150,000
4,000	30,000	250,000
4,700	40,000	1 Megohm
5,000	60,000	2 Megohms

**OUR PRICE 75c PER DOZ**

### R. C. A. Loudspeaker 103

A beautiful speaker, superb in its faithful reproduction. Molded frame and pedestal resemble hand carved oak. Mechanism concealed by attractive tapestry.



(Genuine R.C.A.)  
List \$18.00  
**OUR PRICE \$3.43**

### Atwater-Kent Condenser & Filter Block

For Model 37 and 38 Sets

Ideal filtering system for ANY make A. C. set using 171-A tube. Contains proper chokes and high voltage condensers. Flexible wire colored leads same as original.

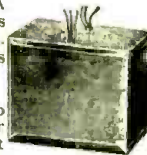

**HOOK-UP**  
Green wire to 280, black to R.F. plate, yellow to Power Tube plate, white to first audio by-pass, white to C.T. of 226 resistance, red to detector plate. Wire from PRICE can to ground.

**\$2.95**

### Kolster K-6 Speaker

Magnetic type tone speaker. Remarkable tone quality; volume to spare. Beautifully carved, fine Walnut cabinet. Equipped with highly sensitive oversize magnet and driving unit. Faithful reproduction from the faintest whisper to fullest volume of a brass band.



List \$20.00  
**OUR PRICE \$3.35**

### AIR-KING

### Superheterodyne S.W. Converter

The greatest converter ever built.

Brings in European stations clear as a bell. Converts any set into a short wave receiver. Employs 3-227 tubes; covers from 20 to 115 meters. Coil switch covers all wave lengths. Single dial control, no body capacity, no squeals. Has built-in filament transformer to heat the 3-227's. All you need from your receiver is a positive B voltage from 45 to 180 volts. Voltage is not critical; no modulation of the receiver. Size 7x10x5 in. Weight 8 lbs.



**OUR PRICE \$14.70**

### New Type Elkon Dry Disc Rectifier

Standard on "A" Eliminators for Majestic, Mayolian, Webster, Elkon, Bernard, Fada, Knapp, Sentinel, Metro, General Instrument, Philco (Elkon equipped) and also on Elkon 3 amp., and Briggs & Stratton chargers.

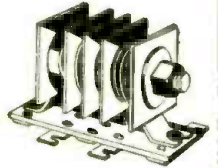

List \$7.00

**OUR PRICE \$3.45**

### Baldwin Rival Unit



This Nathaniel Baldwin unit is one of the finest. For phonograph, automobile and portable radio outfits. We offer this famous unit now at a sensationally reduced price.

**OUR PRICE 50c**

### VICTOR ABC Power Transformer

For use with 6-226, 2-245, 1-227 and 1-280 tubes. Magnetically shielded preventing hum. Can safely be overloaded 30%. High voltages, 400 volts at 150 mils on either side of center tap. Extra large case especially designed to prevent overheating.

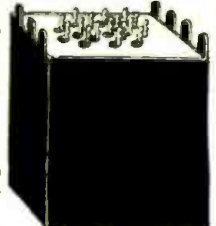

Can Be Used For Any Power Amplifier Using 245 Tubes

Size: 4 1/2 x 5 x 5 1/2 inches.  
No. 1—Center tap of 9 and 14 (5 volts).  
No. 2 and 4—2 1/2 Volts.  
No. 5 and 7—1 in. V. High amp. (226).  
No. 3 and 6—Primary (110V. input).  
No. 8—Center tap of 12 and 17 (2 1/2 V.)  
No. 9 and 14—5 Volts (280).  
No. 10 and 15—High voltage for B supply.  
No. 16—Center tap of above.  
No. 12 and 17—2 1/2 in. volts high amp. (224).

**OUR PRICE \$2.10**

### FREE Catalog—means money to you

These are only a few samples of the values to be found in our catalog. It is full of items on which you can make from 50% to 300% profit. And the best of them is, they are sound, well known, trademarked articles you can depend upon.

Send 20¢ with the order and articles will be shipped C.O.D. Order any of the above articles direct from this page. And be sure to ask for the catalog. It means money to you!

**RADIO CIRCULAR CO.**  
225 Varick St. New York City

## ORDER DIRECT... from this page!

## TEAR IT OUT NOW!

**RADIO CIRCULAR CO., 225 Varick Street, New York City**

Enclosed find \$..... This is 20% of items listed below. I will pay balance upon receipt of merchandise.  
We regret that we cannot accept orders under \$5.00.

## Send for FREE catalog!

**RADIO CIRCULAR CO.**  
225 Varick Street, New York City

Please send me your catalog of radio bargains I can make a profit on.  
I understand this obligates me in no way.

Name.....

Name.....

Address.....

Address.....

Also please send catalog.

City.....

State.....



# NOW—A Powerful New 11-Tube Super Heterodyne at a Sensationally Low Price!

Save 50%  
up to



Easy Terms

Pay as you Play Your Mid-west! Terms as low as \$5.00 Down

only \$37.50  
COMPLETELY ASSEMBLED  
With Specially Matched Large DYNAMIC SPEAKER

30 DAYS FREE TRIAL

Push-Pull Pentode Power Output Tubes—Multi-Mu Screen Grid Tubes—Real Automatic Volume Control—All the Latest Improvements That Give Amazing Clarity, Perfect Tone, Split-Hair Selectivity and Sensitivity Never Before Heard Of!

RADIO-FANS! Just what you've been looking for! A powerful, new 11-tube radio at an unbelievable low price. And what a radio! Two Push-pull pentode power output tubes with twice the power and four times the sensitivity of ordinary 45's—and three Multi-Mu tubes, together with a -24 first detector, gives you SIX SCREEN GRIDS. These six screen grids, together with the -27 oscillator, second detector first A.F., and automatic volume control—the -80 tubes—gives a total of ELEVEN TUBES, with reception equal to fifteen ordinary tubes—in a perfectly balanced, non-oscillating, non-radiating, super-heterodyne TEN-TUNED circuit with real Automatic Volume Control that holds those powerful locals down to the same volume as the distant stations and counteracts that annoying fading on weak stations.

The use of a band-pass or pre-selector stage, together with Multi-Mu tubes, makes this radio actually surpass 10 K.C. selectivity. Absolutely eliminates those noisy singing "birdies" and annoying cross talks. You'll be positively amazed and delighted when you see this sensational new set, hear the beautiful mellow, cathedral tone—know what it means to have that pin-dot selectivity and unequalled sensitivity.

Be convinced—TRY IT 30 DAYS FREE. Don't send a penny. Mail coupon right now for amazing FREE trial offer and complete details. You'll be surprised.

**TERMS**  
as low as  
**\$5.00**  
**DOWN**

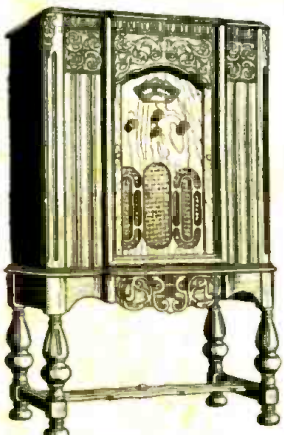

Complete Line of Consoles

Deal Direct with Big Mid-West Factory

—Save Middlemen's Profits

Never before in the history of radio has such a powerful set been offered at Mid-West's amazing low price. Deal direct with the big MID-WEST factory. Save the jobber's profit. Your outfit will reach you splendidly packed, rigidly tested with everything in place ready to plug in. No assembling! Entertain yourself for 30 days absolutely FREE—then decide. Save up to 50 per cent in buying direct from factory—insure satisfaction—deal direct with the world's veteran radio builders—MID-WEST. And don't forget—every MID-WEST outfit is backed by an absolute guarantee of satisfaction. You take no risk.

Rush the coupon for big, beautiful catalog that illustrates the complete line of MID-WEST console cabinets. All new, all different, all priced to save you 30% to 50%. You'll gasp with admiration when you see the vast selection of beauty, style and grace that is crafted into every MID-WEST Console. The catalog is FREE—it doesn't cost you a penny! Rush the coupon—NOW!

Big Pay for USER AGENTS

If you are interested in making BIG MONEY in spare time for just showing your MID-WEST Radio to friends and neighbors, then check the coupon and mail it immediately for complete details. Special guarantee and FREE trial offer eliminates all risk. Your big opportunity—Hurry!

**RUSH THIS COUPON FOR AMAZING FREE TRIAL OFFER AND BIG BEAUTIFUL CATALOG**

Enclose Special "User Agent" proposition.

Mid-West Radio Corp.  
Dept. 22, Cincinnati, Ohio

Gentlemen: Please rush my copy of your big, beautiful new catalog and complete details about the powerful, new 11-tube super-heterodyne outfit. This is not an order, and I am not obligated.

Name \_\_\_\_\_ Address \_\_\_\_\_ Town \_\_\_\_\_ State \_\_\_\_\_

**MID-WEST RADIO CORP.**  
DEPT. 22 CINCINNATI OHIO  
EST. 1919



# NOW

## On All Newsstands

### 25c The Copy

4-Color Cover  
Over 100 Illustrations  
96 Pages—9x12 in.

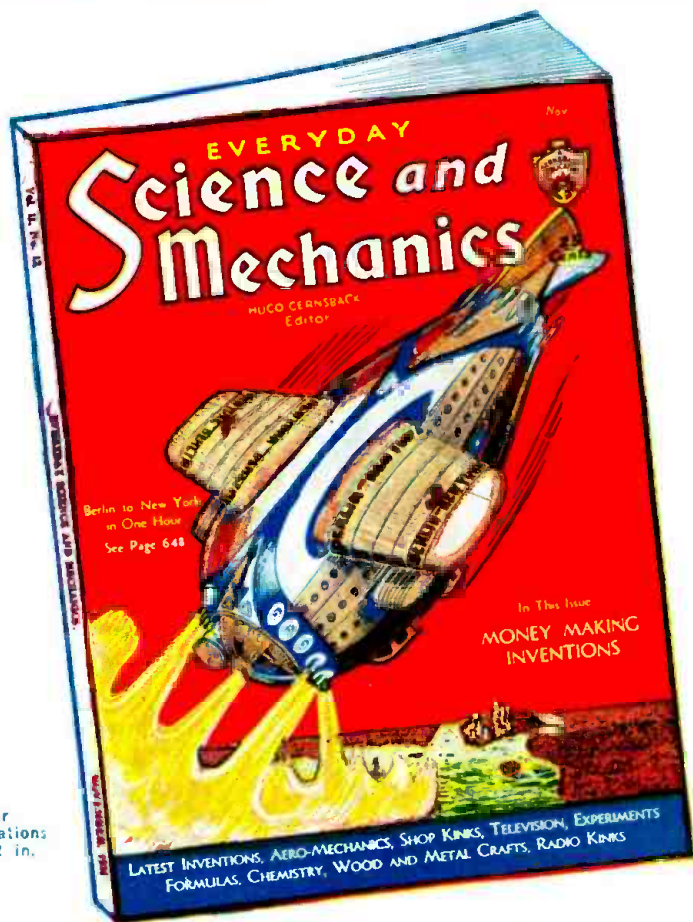

The collage contains several technical diagrams and illustrations. On the left, there are diagrams for a "7-METER WAVE-WAVE" transmitter, a "VOICE TRANSMITTER AT CROSS BAY, LONG ISLAND, N.Y.", and a "TELEPHONE CIRCUIT". In the center, there is a large diagram of a "COLUMBIA BROADCASTING STUDIO (TELEVISION)" showing a "PHOTO CELLS" setup with a "LENS" and "SYNCH MOTOR". To the right, there are various circuit diagrams, including one for a "VOICE RECEIVER (SHORT-WAVE REC.)" and another for a "VOICE TRANSMITTER". At the bottom, there is a diagram of a "VOICE RECEIVER (SHORT-WAVE REC.)" and a "VOICE TRANSMITTER" with a "NEON TUBE" and "1200 R.P.M. SYNCHRONOUS MOTOR".

### TO MY RADIO FRIENDS WILL YOU BET 25c ON ME?

I want to ask you, as a special favor, to stop at your nearest newsstand and get an issue of **EVERYDAY SCIENCE AND MECHANICS** on the following unprecedented arrangement: Take the magazine home, look it over carefully and read those articles which are of interest to you. If, when you finish reading the magazine, you have found that you haven't had your money's worth, you may return the magazine to me and I will immediately refund your quarter, plus postage which you paid in returning the magazine.

I am making this unprecedented offer simply to get you acquainted with the magazine, and because I honestly believe that every issue of **EVERYDAY SCIENCE AND MECHANICS** will be worth many dollars to you with the important information you can't get elsewhere.

### RADIO AND TELEVISION

I want you to look particularly at the new radio and television section containing a tremendous amount of information for radio experimenters, of the kind you cannot possibly get elsewhere.

This special offer to you is good during the month of November only. I hope you will do me the favor to take me up on this unprecedented proposition. Won't you please write and tell me how the book strikes you?

Cordially yours,

H. GERNSBACK.

EVERYDAY SCIENCE AND MECHANICS

100 Park Place, New York, N. Y.



# —“I HAVEN'T MISSED A SINGLE BROADCAST

OF LOUDSPEAKER RECEPTION, WITH ABSOLUTELY EVERY WORD AUDIBLE SINCE THE FOURTH DAY OF LAST APRIL, OF STATION VK3ME (MELBOURNE, AUSTRALIA), EVERY PROGRAM LOGGED IN MY LOG BOOK”

... writes a Lincoln owner in the mountains of Tennessee. (Name and address on request.)

He continues: “This not only applies to Melbourne, but

## I HAVE NOT MISSED A SINGLE TEST

of JIAA, Kemukawa, Japan since May 1st, as my records indicate. Other stations the world over are received on their schedules as regular as clockwork. Even the little 1½ KW station of Ponzon, Poland is received on its wave of 31.35M regularly every Tuesday and Thursday.”

“Even with all the thrill that short waves possess, a new one comes when foreigners are logged on the broadcast band. Last week when I received Sydney, Honolulu, and Osaka (Japan), all in one morning, it makes a feeling come that almost takes away the thought of the prevailing period of depression. It is almost weird to turn on the set in the mid-day and log over thirty stations from seventy-five to twenty-five hundred miles distant, but, I add that the day it occurred was the best day of reception that I have had on broadcast in many months.”

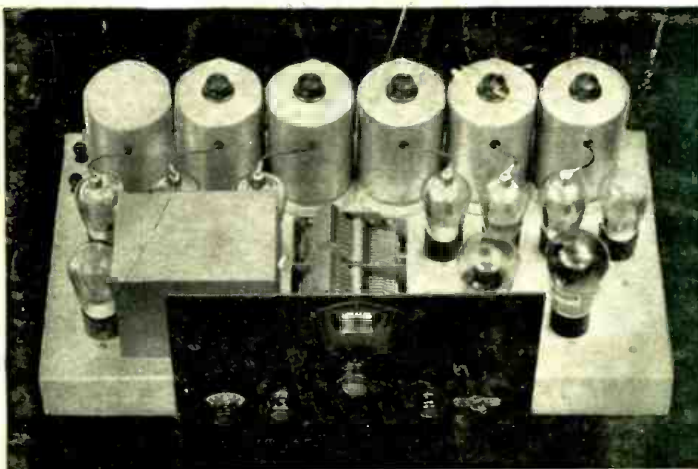

## Super Power Means Super Performance IN YOUR HOME

**15 to 550  
METERS**

**NO  
PLUG-IN  
COILS**

**GLOBE-  
CIRCLING  
POWER**

**LABORATORY  
CONSTRUCTED  
BY COMPETENT  
ENGINEERS**

**A** SLIGHT touch of a switch puts the tremendous power of a Lincoln DeLuxe to work for you. POWER that pulls in programs from the four corners of the earth, that spans the seven seas to bring fascinating programs from foreign lands into your own home! POWER that enables Lincoln owners to enjoy enviable records of almost unbelievable performance! However, sheer power alone could not effect such remarkable results. The overwhelming success of Lincoln receivers is due to precise and positive control of the exceptionally high amplification derived from four tuned I. F. stages.

### Globe Circling Power Applied to Short Waves

The Lincoln short wave feature is not to be confused with hastily improvised “converters,” “adapters” or other accessory units that are being used in some receivers. Lincoln engineers have succeeded in designing the DeLuxe to accommodate short waves in precisely the same manner as the reception of broadcast stations. This feature is inherent in the receiver itself, and has no external parts or connections. Each band of short wave frequencies is tuned through its permanently placed coils and is passed through the high-gain, screen-grid I. F. stages exactly the same as broadcast frequencies, thereby utilizing the entire resources of the famous Lincoln circuit.

A small no-capacity selector switch on the front panel gives instant access to any of the four bands of short waves or the broadcast band.

### DeLuxe DC-SW-10 Battery Model is a Marvel of Crystal-Clear World-Wide Performance

From its first public appearance the Lincoln DeLuxe DC-SW-10 has achieved universal success. Retaining the identical engineering features that has placed Lincoln A. C. equipment far ahead of the field, the DC-SW-10 battery model offers extremely quiet, crystal-clear reception of both broadcast and short wave programs.

Availing themselves of the new low drain tubes, Lincoln engineers were completely successful in duplicating the mighty power, hair-line selectivity and famous Lincoln tone quality of the A. C. models. In addition, the DeLuxe DC-SW-10 is astonishingly quiet in operation and possesses a richness of tone that is truly phenomenal. Although primarily designed for rural and un electrified sections, the DeLuxe DC-SW-10, because of its freedom from line-noise and its marvelous tone quality is finding increasing favor in urban homes.

### COUPON

Clip and mail the coupon for complete information about the Lincoln DeLuxe SW-32 (110V-60 cycle A. C.) and the DeLuxe DC-SW-10 (battery model) receivers.

## LINCOLN RADIO CORPORATION

Dept. RC-1, 329 S. Wood St., CHICAGO, ILL.

Name.....  
Street.....  
City..... State.....